

IND231/IND236

Weighing Terminal



METTLER TOLEDO

IND231/IND236

Weighing Terminal

METTLER TOLEDO Service

Essential Services for Dependable Performance of Your IND231/IND236 Weighing Terminal

Congratulations on choosing the quality and precision of METTLER TOLEDO. Proper use of your new equipment according to this Manual and regular calibration and maintenance by our factory-trained service team ensures dependable and accurate operation, protecting your investment. Contact us about a service agreement tailored to your needs and budget. Further information is available at www.mt.com/service.

There are several important ways to ensure you maximize the performance of your investment:

1. **Register your product:** We invite you to register your product at www.mt.com/productregistration so we can contact you about enhancements, updates and important notifications concerning your product.
2. **Contact METTLER TOLEDO for service:** The value of a measurement is proportional to its accuracy – an out of specification scale can diminish quality, reduce profits and increase liability. Timely service from METTLER TOLEDO will ensure accuracy and optimize uptime and equipment life.
 - a. **Installation, Configuration, Integration and Training:** Our service representatives are factory-trained, weighing equipment experts. We make certain that your weighing equipment is ready for production in a cost effective and timely fashion and that personnel are trained for success.
 - b. **Initial Calibration Documentation:** The installation environment and application requirements are unique for every industrial scale so performance must be tested and certified. Our calibration services and certificates document accuracy to ensure production quality and provide a quality system record of performance.
 - c. **Periodic Calibration Maintenance:** A Calibration Service Agreement provides on-going confidence in your weighing process and documentation of compliance with requirements. We offer a variety of service plans that are scheduled to meet your needs and designed to fit your budget.

© METTLER TOLEDO 2014

No part of this manual may be reproduced or transmitted in any form or by any means, electronic or mechanical, including photocopying and recording, for any purpose without the express written permission of METTLER TOLEDO.

U.S. Government Restricted Rights: This documentation is furnished with Restricted Rights.

Copyright 2014 METTLER TOLEDO. This documentation contains proprietary information of METTLER TOLEDO. It may not be copied in whole or in part without the express written consent of METTLER TOLEDO.

METTLER TOLEDO reserves the right to make refinements or changes to the product or manual without notice.

COPYRIGHT

METTLER TOLEDO® is a registered trademark of Mettler-Toledo, LLC. All other brand or product names are trademarks or registered trademarks of their respective companies.

METTLER TOLEDO RESERVES THE RIGHT TO MAKE REFINEMENTS OR CHANGES WITHOUT NOTICE.

FCC Notice

This device complies with Part 15 of the FCC Rules and the Radio Interference Requirements of the Canadian Department of Communications. Operation is subject to the following conditions: (1) this device may not cause harmful interference, and (2) this device must accept any interference received, including interference that may cause undesired operation.

This equipment has been tested and found to comply with the limits for a Class A digital device, pursuant to Part 15 of FCC Rules. These limits are designed to provide reasonable protection against harmful interference when the equipment is operated in a commercial environment. This equipment generates, uses, and can radiate radio frequency energy and, if not installed and used in accordance with the instruction manual, may cause harmful interference to radio communications. Operation of this equipment in a residential area is likely to cause harmful interference in which case the user will be required to correct the interference at his or her expense.

- Declaration of Conformity is located on the documentation CD.

RoHS Compliance Statement.















- The majority of our products fall within categories 8 and 9. Those categories currently do not fall within the scope of the Directive 2002/95/EG (RoHS) of January 27, 2003. If our products are intended for use in other products which themselves fall within the scope of the RoHS Directive, compliance requirements have to be separately negotiated contractually.
- Those products which fall within categories 1-7 and 10 will be in compliance with the EU RoHS Directive from no later than July 1, 2006.
- If it is not possible for technical reasons to replace any non-RoHS-compliant substances in any of the above products as required, we plan to inform our customers in a timely manner



Statement regarding harmful substances

We do not make direct use of harmful materials such as asbestos, radioactive substances or arsenic compounds. However, we purchase components from third party suppliers, which may contain some of these substances in very small quantities.

Warnings and Cautions

- READ this manual BEFORE operating or servicing this equipment and FOLLOW these instructions carefully.
- SAVE this manual for future reference.

	<p style="text-align: center;"> WARNING</p> <p>FOR CONTINUED PROTECTION AGAINST SHOCK HAZARD CONNECT THE AC VERSION OF THE IND231/IND236 TERMINAL TO PROPERLY GROUNDED OUTLET ONLY. DO NOT REMOVE THE GROUND PRONG.</p>
	<p style="text-align: center;"> WARNING</p> <p>ONLY PERMIT QUALIFIED PERSONNEL TO SERVICE THE TERMINAL. EXERCISE CARE WHEN MAKING CHECKS, TESTS AND ADJUSTMENTS THAT MUST BE MADE WITH POWER ON. FAILING TO OBSERVE THESE PRECAUTIONS CAN RESULT IN BODILY HARM AND/OR PROPERTY DAMAGE.</p>
	<p style="text-align: center;"> WARNING</p> <p>THE IND231/IND236 IS NOT DESIGNED FOR USE IN AREAS CLASSIFIED AS HAZARDOUS BECAUSE OF COMBUSTIBLE OR EXPLOSIVE ATMOSPHERES. DO NOT INSTALL AN IND231/IND236 INTO AN EXPLOSIVE ENVIRONMENT.</p>
	<p style="text-align: center;"> WARNING</p> <p>WHEN THIS EQUIPMENT IS INCLUDED AS A COMPONENT PART OF A SYSTEM, THE RESULTING DESIGN MUST BE REVIEWED BY QUALIFIED PERSONNEL WHO ARE FAMILIAR WITH THE CONSTRUCTION AND OPERATION OF ALL COMPONENTS IN THE SYSTEM AND THE POTENTIAL HAZARDS INVOLVED. FAILURE TO OBSERVE THIS PRECAUTION COULD RESULT IN BODILY HARM AND/OR PROPERTY DAMAGE.</p>
	<p style="text-align: center;"> CAUTION</p> <p>THE NiMH BATTERY USED IN THIS DEVICE MAY PRESENT A RISK OF FIRE OR CHEMICAL BURN IF MISTREATED. DO NOT CRUSH, DISASSEMBLE, HEAT ABOVE 60°C OR INCINERATE. REPLACE BATTERY WITH 30044650 ONLY. USE OF ANOTHER BATTERY MAY PRESENT A RISK OF BURN, FIRE OR EXPLOSION.</p>
	<p style="text-align: center;"> CAUTION</p> <p>USE CAUTION WHEN TESTING THE BATTERY. A LARGE AMOUNT OF CURRENT MAY BE PRESENT IN THE BATTERY.</p>
	<p style="text-align: center;"> CAUTION</p> <p>DISPOSE OF USED BATTERY PROMPTLY. KEEP AWAY FROM CHILDREN. DO NOT DISASSEMBLE AND DO NOT DISPOSE OF IN FIRE.</p>

	 CAUTION
	<p>BEFORE CONNECTING/DISCONNECTING ANY INTERNAL ELECTRONIC COMPONENTS OR INTERCONNECTING WIRING BETWEEN ELECTRONIC EQUIPMENT ALWAYS REMOVE POWER AND WAIT AT LEAST THIRTY (30) SECONDS BEFORE ANY CONNECTIONS OR DISCONNECTIONS ARE MADE. FAILURE TO OBSERVE THESE PRECAUTIONS COULD RESULT IN DAMAGE TO OR DESTRUCTION OF THE EQUIPMENT AND/OR BODILY HARM.</p>

<p><i>NOTICE</i></p>
<p>DO NOT ATTEMPT TO CHARGE THE Ni-MH BATTERY IF THE BATTERY TEMPERATURE IS BELOW 0°C (32°F). CHARGING IS NOT POSSIBLE AT OR BELOW THIS TEMPERATURE. DO NOT OPERATE THE BATTERY CHARGER OUTSIDE ITS TEMPERATURE RANGE OF 0°C (32°F) TO 40°C (104°F).</p>

<p><i>NOTICE</i></p>
<p>TO AVOID DAMAGE TO THE PCB OR LOAD CELL, REMOVE POWER FROM THE IND231/IND236 TERMINAL AND WAIT AT LEAST 30 SECONDS BEFORE CONNECTING OR DISCONNECTING ANY HARNESS.</p>

	<p><i>NOTICE</i></p>
	<p>OBSERVE PRECAUTIONS FOR HANDLING ELECTROSTATIC SENSITIVE DEVICES.</p>

Disposal of Electrical and Electronic Equipment

In conformance with the European Directive 2002/96/EC on Waste Electrical and Electronic Equipment (WEEE) this device may not be disposed of in domestic waste. This also applies to countries outside the EU, per their specific requirements.



Please dispose of this product in accordance with local regulations at the collecting point specified for electrical and electronic equipment.

If you have any questions, please contact the responsible authority or the distributor from which you purchased this device.

Should this device be passed on to other parties (for private or professional use), the content of this regulation must also be related.

Thank you for your contribution to environmental protection.

Contents

1	Introduction	1-1
1.1.	IND231/IND236 Overview	1-1
1.1.1.	Standard Features	1-1
1.1.2.	IND231/IND236 Terminal Types	1-2
1.2.	Use in Hazardous Areas.....	1-2
1.3.	Specifications	1-2
1.4.	Model Identification	1-4
1.5.	Inspection and Contents Checklist	1-5
1.6.	Physical Dimensions.....	1-5
1.7.	Main PCB	1-6
1.8.	Scale Bases	1-7
1.9.	Options.....	1-7
1.9.1.	Isolated Serial interface RS232/RS422/RS485.....	1-7
1.9.2.	Discrete I/O.....	1-7
1.9.3.	USB	1-7
1.10.	Display and Keyboard	1-8
1.10.1.	Display Layout.....	1-8
1.10.2.	Front Panel Keys	1-8
2	Operation	2-1
2.1.	Overview.....	2-1
2.2.	Keypad Operation and Display Elements.....	2-1
2.2.1.	Keypad Operation.....	2-1
2.2.2.	Display Elements	2-3
2.3.	Configurable Function Keys	2-5
2.3.1.	Configuring Function Keys	2-5
2.3.2.	Function keys assignment	2-6
2.4.	Basic Functionality	2-6
2.4.1.	Expand x 10.....	2-6
2.4.2.	Unit Switching	2-7
2.4.3.	Date and Time	2-8
2.4.4.	Backlight Adjustment	2-8
2.4.5.	Zero	2-8
2.4.6.	Tare	2-9
2.4.7.	Print.....	2-10
2.5.	Remote Display Functionality.....	2-11
2.5.1.	Introduction	2-11
2.5.2.	Setup	2-11
2.5.3.	Remote Display Operation	2-13

2.6.	Applications	2-14
2.6.1.	Checkweighing.....	2-14
2.6.2.	Target Recall.....	2-17
2.6.3.	Counting	2-18
2.6.4.	Animal Weighing.....	2-20
2.6.5.	Accumulation.....	2-21
3	Configuration	3-1
3.1.	Accessing Setup Mode.....	3-1
3.1.1.	Entering Setup Mode.....	3-1
3.1.2.	Exiting Setup Mode.....	3-2
3.1.3.	Setup Menu Navigation	3-3
3.2.	Setup Menu Structure.....	3-5
3.2.1.	Main setup menu	3-5
3.2.2.	Configurable function keys	3-5
3.3.	Configuration Overview	3-6
3.4.	F1 Scale	3-7
3.4.1.	F1.1 Scale type.....	3-7
3.4.2.	F1.2 Capacity and Increment.....	3-9
3.4.3.	F1.3 Calibration	3-11
3.4.4.	F1.4 Zero	3-13
3.4.5.	F1.5 Tare	3-15
3.4.6.	F1.6 Second Units.....	3-17
3.4.7.	F1.7 Filter.....	3-18
3.4.8.	F1.10 Scale Block Reset	3-19
3.5.	F2 Application	3-20
3.5.1.	F2.1 Operation.....	3-20
3.5.2.	F2.2 Over/Under Database	3-22
3.5.3.	F2.3 Counting.....	3-26
3.5.4.	F2.4 Animal Weighing	3-26
3.5.5.	F2.5 Discrete I/O	3-27
3.5.6.	F2.10 Application Block Reset	3-28
3.6.	F3 Terminal.....	3-29
3.6.1.	F3.1 Serial Number	3-29
3.6.2.	F3.2 Display.....	3-29
3.6.3.	F3.3 Date & Time.....	3-31
3.6.4.	F3.10 Terminal Block Reset.....	3-32
3.7.	F4 Communication	3-33
3.7.1.	F4.1 COM1.....	3-33
3.7.2.	F4.2 – COM 2.....	3-36
3.8.	F5 Maintenance	3-38
3.8.1.	F5.1 Calibration values.....	3-38
3.8.2.	F5.2 – Statistics	3-39
3.8.3.	F5.3 Keyboard Test	3-39

3.8.4.	F5.4 Display Test	3-40
3.8.5.	F5.5 Serial Test	3-40
3.8.6.	F5.6 Discrete I/O Test	3-41
3.8.7.	F5.7 Raw counts	3-41
3.8.8.	F5.8 Print Configuration	3-42
3.8.9.	F5.10 Reset All to Factory Default Settings	3-42
4	Service and Maintenance	4-1
4.1.	Cleaning and Maintenance	4-1
4.2.	Service	4-1
4.3.	Battery Operation	4-2
4.3.1.	Battery Use	4-2
4.3.2.	Battery Disposal	4-2
4.3.3.	Battery Status Icon	4-3
4.3.4.	Alkaline Battery Version	4-4
4.3.5.	Rechargeable NiMH Battery Pack Version	4-5
4.4.	Troubleshooting	4-5
4.4.1.	Battery Power	4-5
4.4.2.	Problem Diagnosis	4-6
4.4.3.	Error Codes and Error Messages	4-6
4.4.4.	Scale Statistics	4-8
4.5.	Connection to InSite™	4-8
A	Parameter Values	A-1
B	Communications	B-1
B.1.	Serial Interface Parameters	B-1
B.2.	Demand Output Mode	B-1
B.2.1.	Output Templates	B-2
B.3.	Continuous Output Mode	B-4
B.3.1.	Standard Continuous Output	B-5
B.4.	CTPZ	B-7
B.5.	Standard Interface Command Set (SICS) Protocol	B-7
B.5.1.	Version Number of the MT-SICS	B-8
B.5.2.	Command Formats	B-8
B.5.3.	Response Formats	B-9
B.5.4.	Tips for the Programmer	B-10
B.5.5.	Commands and Responses MT-SICS Level 0	B-11
B.5.6.	Commands and Responses MT-SICS Level 1	B-15
B.5.7.	Commands and Responses MT-SICS Level 2	B-18
B.5.8.	Commands and Responses MT-SICS Level 3	B-18
C	GEO Codes	C-1
C.1.	Original Site Calibration	C-1

C.2. New Site GEO Code Adjustment C-1

1 Introduction

This chapter covers

- Overview of IND231/IND236
- Use in Hazardous Areas
- Specifications
- Model Identification
- Inspection and Contents Checklist
- Physical Dimensions
- Main PCB
- Scale Bases
- Options
- Display and Keyboard

The IND231/IND236 industrial scale terminal provides a compact yet flexible solution for a variety of weighing needs. Available as either AC powered for stationary applications or battery-powered for portable applications, this terminal is at home in virtually any industrial environment.

Both 2mv/V and 3mv/V load cells are supported without the need for any configuration change. The IND231/IND236 delivers precision measurement data from grams to kilograms in a single, cost effective package.

Standard applications include basic weighing, animal weighing, Over/Under checkweighing, counting and accumulation. Pre-defined application-specific print templates including date and time stamp, provide transmission of weighing transaction information to printers and PC software applications.

1.1. IND231/IND236 Overview

1.1.1. Standard Features

- Easy to handle plastic enclosure design for the IND231, rugged stainless steel enclosure for the IND236
- Supports one analog load cell platform with up to four 350Ω load cells
- Can be used as a remote display to show weight from a separate main terminal
- Large seven segment LCD display with white backlight and graphic icons for clear readability in varying light conditions
- Powered by either 85–264 V AC or internal battery pack
- One standard serial port (COM1) for asynchronous, bidirectional communication
- Support for one of the following option boards:
 - COM2 electrically isolated RS232, RS422 and RS485 serial Interface
 - USB device Interface for connection to a PC
 - Discrete I/O interface
- Front panel key access to basic weighing functions – zero, tare, clear, configurable function and print
- Selectable primary unit of measure including grams, kilograms, pounds and ounces
- Selectable second unit of measure including grams, kilograms, pounds and ounces

- Backup and restore of configuration and calibration settings, using InSite® SL tool
- WeighSync™ ST simple data integration software for weighing terminals
- Automatic shutoff and backlight timeout features to help conserve energy and extend battery life when using the battery powered version

1.1.2. IND231/IND236 Terminal Types

The terminal is available in the following four versions:

- IND231 plastic housing, AC power (also designed for use with AA size alkaline cells)
- IND231 plastic housing, Rechargeable Ni-MH Battery power
- IND236 stainless steel housing, AC power
- IND236 stainless steel, Rechargeable Ni-MH battery power

1.2. Use in Hazardous Areas

	 WARNING
	THE IND231/236 TERMINAL DOES NOT HAVE ANY HAZARDOUS AREA APPROVALS! DO NOT USE WITHIN AREAS CLASSIFIED AS HAZARDOUS DIVISION 1/2 OR ZONE 0/1/2/21/22 BECAUSE OF COMBUSTIBLE OR EXPLOSIVE ATMOSPHERES.

The IND231/236 terminal does not have any hazardous area approvals for use directly in explosive environments; however, it is capable of operation with load cells and platforms in a Division 1/2 or Zone 0/1/2/21/22 hazardous area when used with approved barriers or when purging is utilized. Contact your authorized METTLER TOLEDO representative for information about hazardous area applications for the IND231/236 terminal.

1.3. Specifications

The IND231 and IND236 terminal conforms to the specifications listed in Table 1-1.

Table 1-1: Terminal Specifications

Specifications	IND231	IND236
Enclosure Type	Plastic, configurable as desk top or column/wall mount enclosure	Stainless steel, configurable as desk top or column/wall mount enclosure
Product Dimensions (w × h × d)	220 mm x 150 mm x 102 mm (8.66 in. x 5.90 in. x 4.02 in.)	220 mm x 150 mm x 93.3 mm (8.66 in. x 5.90 in. x 3.67 in.)
Shipping Dimensions (w × h × d)	350 mm x 220 mm x 195 mm (13.78 in. x 8.66 in. x 7.68 in.)	
Product Weight	AC Version: 1.2 kg (2.6 lb) Battery Version: 1.5 kg (3.3lb)	AC Version: 2.2 kg (4.9 lb) Battery Version: 2.5 kg (5.5 lb)

Specifications	IND231	IND236
Shipping Weight	2.0 kg	3.0 kg
Environmental Protection	IP54	IP66/67
Operating Environment	Operating temperature range: -10 °C to +40 °C Storage temperature range: -20 °C to +60 °C Relative Humidity: 10-95%, non-condensing.	
Hazardous Areas	The terminal cannot be operated in areas classified as Hazardous because of combustible or explosive atmospheres in those areas. Contact an authorized METTLER TOLEDO representative for information about hazardous area applications.	
Power	AC version: Operates at 85–264 VAC, 49–61 Hz and includes a power cord configured for the country of use.	
	Battery version : Six "AA" size alkaline batteries or NiMH rechargeable battery pack (about 120hrs for one load cell)	Battery version : NiMH rechargeable battery (about 120hrs for one load cell)
Display	40 mm height character, seven digits seven segment LCD with white backlight including weight display, weight units, gross/net indication and symbols for motion, center of zero and variable applications	
Weight Display	Maximum displayed resolution of 30,000 divisions	
Scale Types	Analog load cells	
Number of Cells	Up to four 350 ohm load cells(2 or 3 mV/V)	
Number of Scales	One	
Analog/Digital Update Rate	Internal analog: 80 Hz	
Load Cell Excitation Voltage	5 VDC	
Minimum Sensitivity	0.5 µV/e	
Keypad	Seven keys: Zero, Tare, Clear, On/Off, Print, F1 & F2 (configurable)	
Communication options	Serial Interfaces Standard: One serial port (COM1) RS-232, 1,200 to 115,200 baud Optional isolated serial port: (COM2) RS-232/422/485, 1,200 to 115,200 baud Discrete I/O Interface Optional Discrete I/O port: 2 inputs/4 outputs USB Interface Optional USB device port Protocol Serial Inputs: ASCII commands for CTPZ (Clear, Tare, Print, Zero), SICS (most level 0 and level 1 commands)	
Application	Zero, Tare, Print, X10, Date & Time, Basic weighing, Animal weighing, Counting with APW enhancement, Over/Under checkweighing with 10 records database, Accumulation, Remote display	

Specifications	IND231	IND236
Approvals	Weights and Measures, USA: NTEP Class III/IIIL - 10,000d; Cert. #13-049, Canada: Class III - 10,000d; Class IIIHD - 20,000d, Europe: Class III, 2 x 3000e and 6000e; TC8351, T5976 OIML: Class III, 2 x 3000e and 6000e; R76/2006-NL1-13.06 Product Safety UL, cUL, CE	
Accessories	Wall mount/column mount bracket; desk bracket.	

1.4. Model Identification

The IND231/IND236 model number, factory number and serial number are located on the data plate of the terminal. Refer to Figure 1-1 to verify the configuration of the IND231/IND236 terminal when it left the METTLER TOLEDO factory.

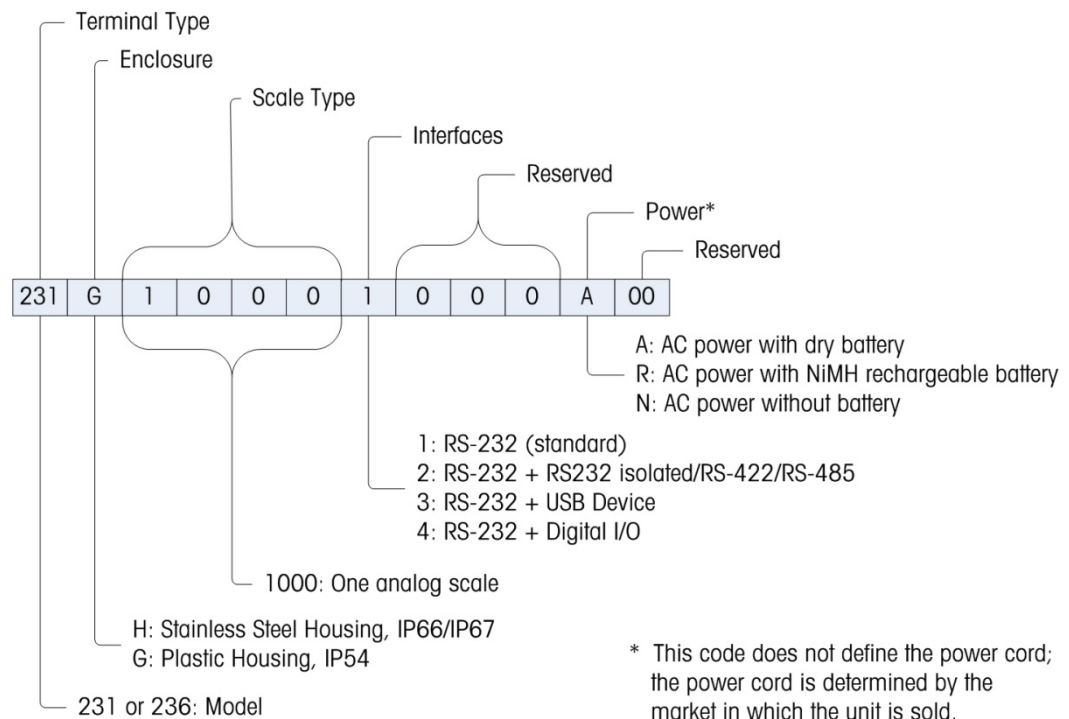

Figure 1-1: IND231 Configuration Chart

1.5. Inspection and Contents Checklist

Verify the contents and inspect the package immediately upon delivery. If the shipping container is damaged, check for internal damage and file a freight claim with the carrier if necessary. If the container is not damaged, remove the terminal from its protective package, noting how it was packed, and inspect each component for damage.

If shipping the terminal is required, it is best to use the original shipping container. The terminal must be packed correctly to ensure its safe transportation.

The package should include:

- IND231 or IND236 Terminal
- Installation Manual (or Safety Instructions)
- Power cord
- Bag of miscellaneous parts
- User manual (or resource CD)
- Battery Pack (battery version only)
- Mounting brackets (1)

1.6. Physical Dimensions

The physical dimensions of the IND231/IND236 enclosure are shown in Figure 1-2 and Figure 1-3 in mm and [inches].

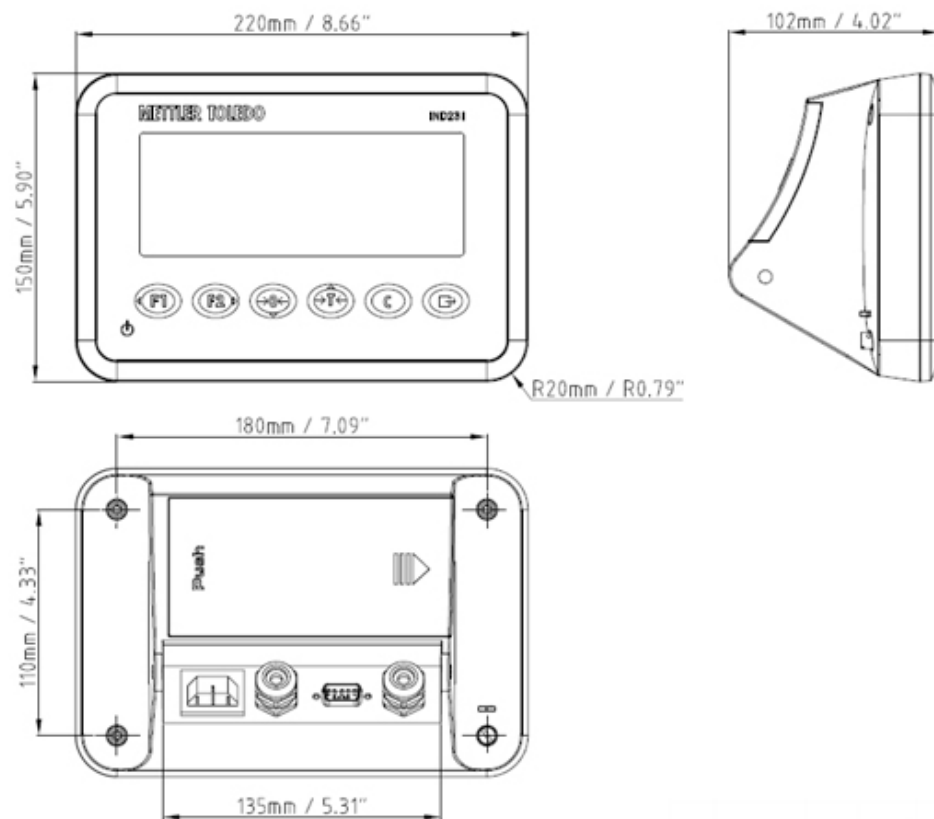

Figure 1-2: IND231 Enclosure Dimensions

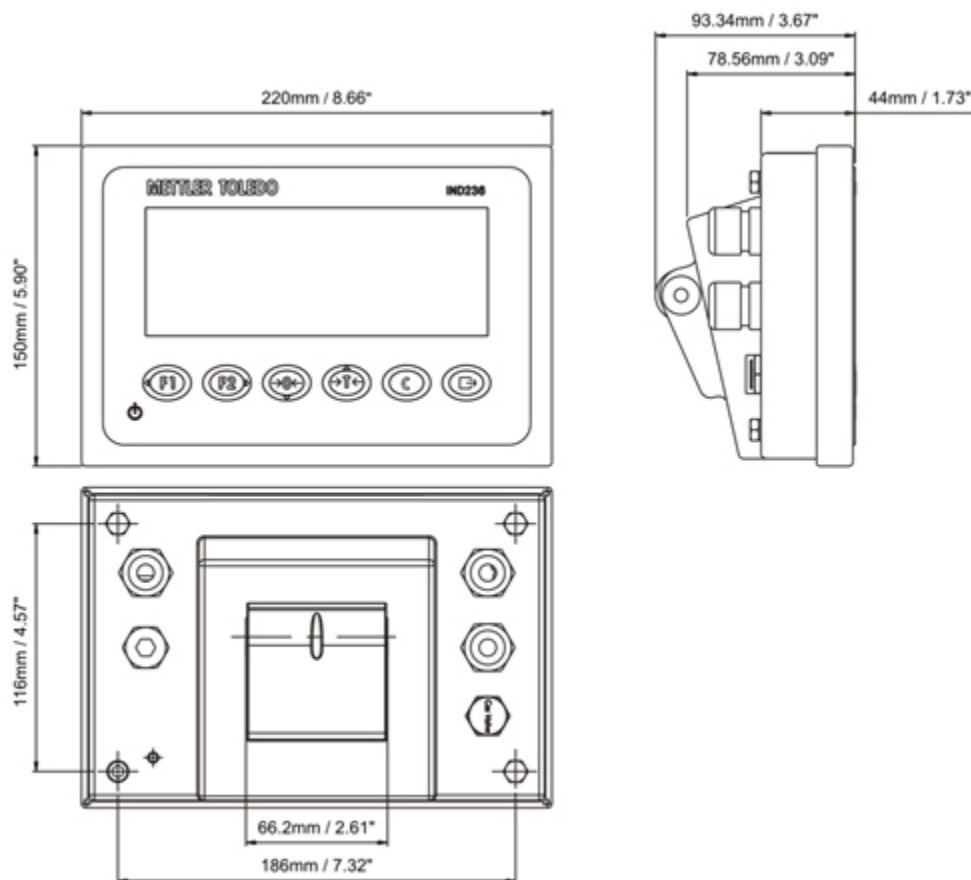

Figure 1-3: IND236 Enclosure Dimensions

1.7. Main PCB

The IND231/IND236 terminal's main printed circuit board (PCB) provides the analog load cell scale interface, as well as the COM1 RS-232 serial port. The COM1 RS-232 serial port supports bi-directional communications at speeds up to 115200 bps. This port can be used for saving terminal configuration data to a PC via the InSite[®] SL tool.

The main board also contains the DC power input connection, display interface, keypad interface, and interface port for the options.

An AC/DC power board supplies the terminal with DC +12V/1A output.

An optional charging board is included with the rechargeable battery powered version.

1.8. Scale Bases

The IND231/IND236 terminal supports analog scale bases and provides 5 volts of excitation to drive analog load cells. Up to four 350Ω load cells can be powered by the terminal.

A four- or six-wire load cell connection is provided, with sense lines to help maintain accuracy as the load cell cable resistance changes due to variations in temperature.

1.9. Options

Three kinds of option interface can be mounted on COM2. The connection pin specifications are printed on the PCB.

The following options are available for the IND231 and IND236.

1.9.1. Isolated Serial interface RS232/RS422/RS485

This optional port provides RS-232 and RS-422/485 communication which can be configured in setup. The port is bidirectional and can be used for various functions such as print, auto print, Toledo continuous output or SICS communications.

The COM2 port is galvanically isolated for both RS-232 and RS-485, to provide surge voltage protection.

The RS-485 connection can be used as an RS-422 transmit only, when sending continuous output to a scoreboard or remote display.

The interface RS422/485 is required for data transmission with higher baud rate over longer distances up to 500 m.

Communication settings can be configured in the terminal setup menu.

1.9.2. Discrete I/O

The discrete I/O interface option provides four dry-contact relay outputs. The relay contacts will switch up to 30 volts DC or 250 volts AC at 1A.

The two inputs are switch selectable as either active (for simple pushbutton control) or passive (for connection to devices that supply their own power for the inputs).

1.9.3. USB

The USB port provided is a UART-USB device bridge acting as a virtual COM port, and is used for communication of serial data to devices such as a PC. The port is bidirectional and can be configured for various functions such as print, auto print, Toledo continuous output or SICS communications. USB external keyboards and bar code scanners are not supported.

The USB driver required to use this port is included on the Resource CD-ROM. A link to the driver files is provided on the **Documentation and Utilities** page.

1.10. Display and Keyboard

IND231/IND236 uses a transfective type segment LCD display with a white backlight. The main character height is 40 mm. The front panel, including display and keypad, is shown in Figure 1-4. The only keypad difference between IND231 and IND236 is the name on the upper right corner of the terminal.

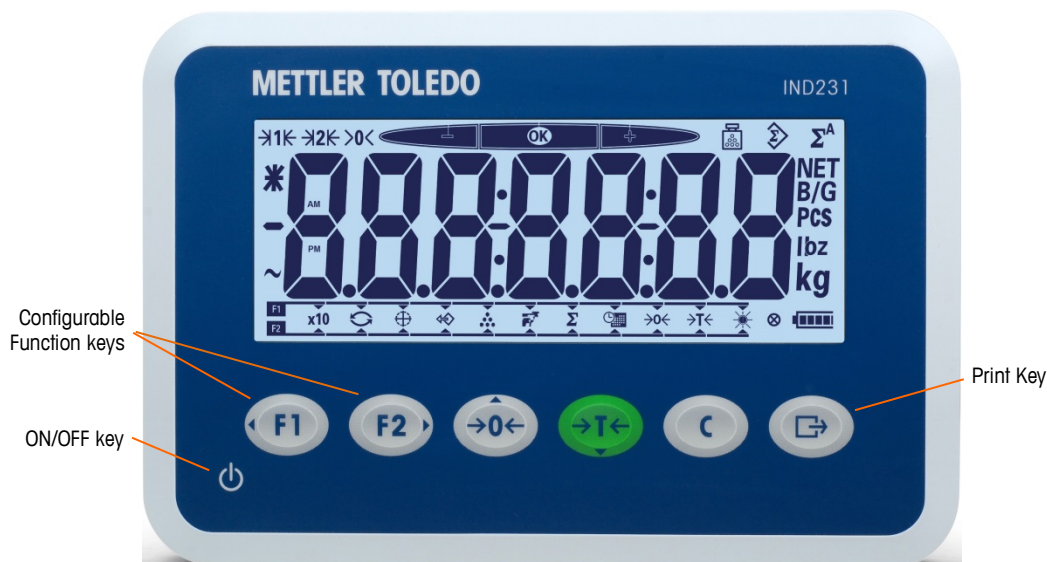

Figure 1-4: IND231 Front Panel Layout

1.10.1. Display Layout

At the top of display, a single system line displays terminal status such as range number, center of zero, checkweighing status, counting, accumulation and auto accumulation.

Below the system line is the weight display block. During normal, basic weighing operation, the terminal display shows the gross or net weight in the larger 40 mm (1.57 in.) size. When one of the applications is running, prompting messages or menu index characters are also shown in 40 mm (1.57 in.) height. At the right of weight display is a vertical column displaying the gross and net symbols, average piece symbol, and weight units. The star symbol, minus symbol and dynamic symbol appear in a column to the left of the weight display block.

At the bottom of the normal basic weighing display is a block used for assigning functions to **F1** and **F2**. For display and keypad operation during setup, refer to Chapter 3, **Configuration**.

1.10.2. Front Panel Keys

The IND231/IND236 terminal operator interface provides a total of seven membrane keys. The print key and five scale function keys (three with fixed function, two with configurable functions) are positioned under the display.

Arrows on the first four keys indicate their use in menu navigation.

The ON/OFF key is located at the bottom left of the display. These keys are used to enter the setup menu, to navigate and select setup elements as described in Chapter 2, **Operation**.

2 Operation

2.1. Overview

This chapter covers

- Overview
- Keypad Operation and Display Elements
- Configurable Function Keys
- Basic Functionality
- Remote Display Functionality
- Applications

This chapter provides information about the basic functionality of the IND231/IND236 terminal, including display operation, keypad functions and configurable function keys.

Operation of the terminal varies depending on which functions are enabled, and on the configuration of parameters in setup. Configuration is described in Chapter 3, **Configuration**.

2.2. Keypad Operation and Display Elements

Refer to Figure 2-1 for an overview of the layout of the front panel of the IND231/ IND236.

2.2.1. Keypad Operation

The front panel keys shown in Figure 2-1 are used to operate and configure IND231/IND236.









Figure 2-1: Front panel

2.2.1.1. Function Keys

Table 2-1 explains the function of each of the keys during normal operation. Further details about keypad functions while in the setup menu are provided in Chapter 3, **Configuration**.

Table 2-1: Keypad Functions – Normal Operation



Keys	Function	Explanation
	FUNCTION 1	Function varies depending on what is selected in the menu.
	FUNCTION 2	Function varies depending on what is selected in the menu.
	ZERO	Used to reset the displayed weight to Zero.
	TARE	Captures current weight as a tare value, and sets terminal to Net mode.
	CLEAR	When in the net weight mode, press CLEAR to clear the current tare value; the display will revert to the gross weight value. CLEAR operates regardless of motion on the scale. Note that once the tare value has been cleared, it cannot be recalled. The complete tare process as described above must be performed.
	Transfer / Print / Enter Key	<ul style="list-style-type: none"> Send information to the RS232 interface Access to setup menu by long pressing the icon Used for printing application Press the ENTER key to accept the item or selection and move to the next display.



- The ZERO and TARE functions will not operate when there is motion on the scale. If one of these keys is pressed while the scale is in motion, the command will be retained for the programmed number of seconds while the terminal waits for no-motion. If a no-motion condition is not detected within the timeout period, the request is cancelled and discarded.

2.2.1.2. Direction Keys

The direction keys in Table 2-2 are used for changing focus between on-screen items, for confirming a selection.

Table 2-2: Direction Keys

Keys	Function	Explanation
	LEFT	<ul style="list-style-type: none"> Move the focus left Back to previous menu
	RIGHT	<ul style="list-style-type: none"> Move the focus right Access to the next submenu

Keys	Function	Explanation
	UP	<ul style="list-style-type: none"> • Move the focus up • Next option
	DOWN	<ul style="list-style-type: none"> • Move the focus down • Previous option

2.2.1.3. Power (On/Off) Key

The power key in Table 2-3 is used for turning the scale on or off. The key needs to be pressed for more than 2 second for powering off.

Table 2-3: Power Key

Keys	Function	Explanation
	On/Off	<ul style="list-style-type: none"> • Turn on or off the terminal • Exit the setup menu • Cancel the edit setting under applications/menu

2.2.2. Display Elements

Figure 2-2 illustrates the appearance of alphabetical characters in the segmented display.

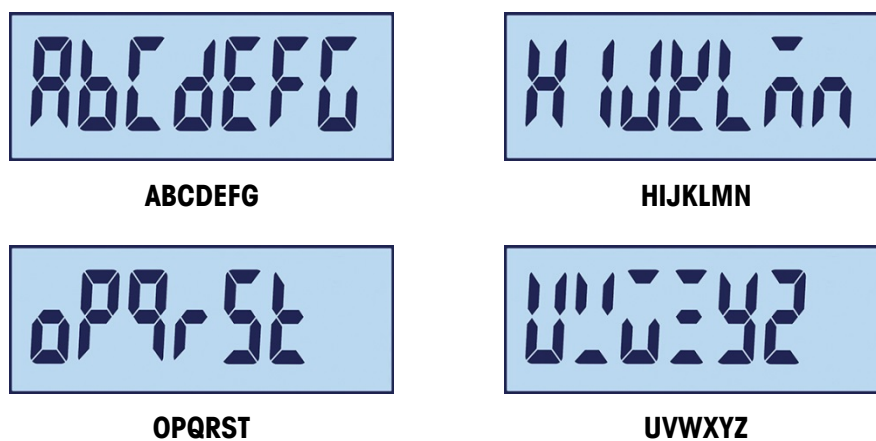

Figure 2-2: Segmented LCD Display of Alphabetical Characters

When in weighing mode, the display is used to indicate weight value and other types of information related to it. Refer to Figure 2-3.

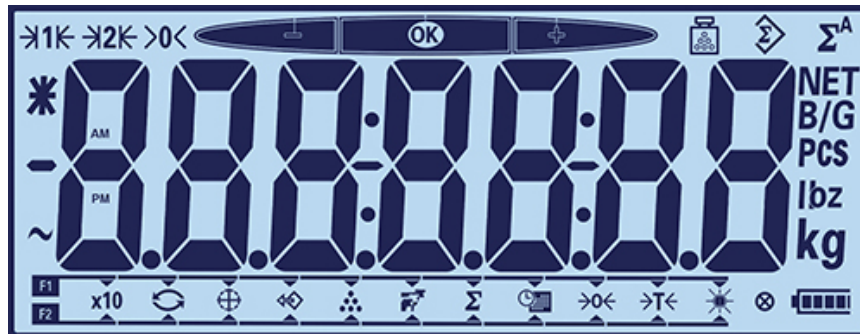

Figure 2-3: Elements of the Display

The symbols that may appear on the display can be divided into three parts:

- At the top of the display, a single system line displays terminal status.
- Below the system line is the weight display.
- At the bottom of the basic basic weighing display is a block used for showing function selection of keys "F1" and "F2".

The symbols are described in Table 2-4.

Table 2-4: Main Display Symbols

Symbol	Explanation	Symbol	Explanation
	Average piece weight		Function keys: F1 & F2
	Accumulation weight		Expand display
	Auto accumulation weight		Unit switch
	Over/Under checkweighing		Check weigh
	Center of zero		Recall
	Range 1, Range 2		Counting
	Averaged or x10 weight		Animal weighing
	Minus value		Accumulation
	Dynamic state		Date & Time
	Dash and colon		Backlight adjust
	B/G and net		Zero
	Display counts		Tare

Symbol	Explanation
lbz kg	Unit

Symbol	Explanation
	Key press indicator
	Battery status

2.3. Configurable Function Keys

Functions typically performed by operators can be accessed using the two function keys. The function key assignments are displayed at the bottom of the normal basic weighing display in IND231/IND236 terminal (Figure 2-4).



Figure 2-4: Available Function Key Assignments

Functions include access to expanding the displayed weight resolution by 10, Unit switching, Checkweighing, Recall, Counting, Animal weighing, Accumulation, Date & Time, Zero & Tare and Backlight, adjustment. The procedure for assigning functions to the keys is described below.

2.3.1. Configuring Function Keys

2.3.1.1. Assignment from the Weighing Screen

To access the function key assignment interface, press and hold the or key when in basic weighing mode. The normal weight display will change to show an array of function icons, as seen in Figure 2-5. The currently selected function is indicated by a small arrow and a line linking it to the F1 or F2 symbol. Use the LEFT and RIGHT direction keys (and) to position the arrow next to the desired function. Figure 2-5 shows the X10 function assigned to F1 (left) and the Switch Units function assigned to F2 (right).

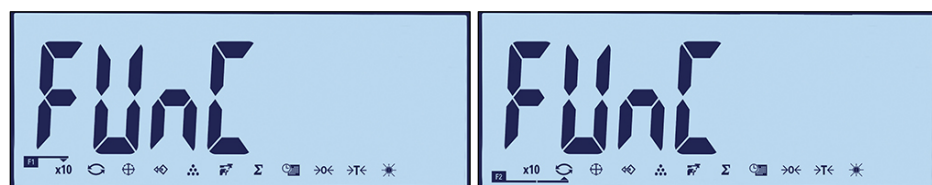

Figure 2-5: Function Keys Assignment Interface

Once the desired assignment is indicated, press the PRINT key to confirm the selection and return to normal weighing mode.











2.3.1.2. Assignment from Setup

Enter setup (refer to Chapter 3, **Configuration**) and access the interface shown in Figure 2-5 at **F2 – Application > F2.1 – Operation > F2.1.1 – Function key 1** and **F2.1.2 Function key 2**. Once the interface screen is displayed, the procedure is as described above under **Assignment**.

2.3.2. Function keys assignment

Options for the assignment of the FUNCTION keys are described in Table 2-5.

Table 2-5: Function assignment

Keys	Function
	Expand display
	Unit switch
	Checkweighing
	Checkweighing Target Recall
	Counting
	Animal weighing
	Accumulation
	Date & Time
	Zero
	Tare
	Backlight adjustment

2.4. Basic Functionality

This section provides information the basic functionality of IND231/IND236. The following functions are addressed in this section:

- Expand x10
- Brightness adjustment
- Print
- Unit Switch
- Zero
- Date & Time
- Tare

Refer to Chapter 3, **Configuration**, for further information about programming the functionality described in this section.

2.4.1. Expand x 10

This icon toggles the weight display between standard and expanded mode. It is used to increase the selected weight display resolution by one additional digit.

For example, an extra digit of resolution is added to the main weight display, which then changes from 2.264 to 2.2645, as shown in Figure 2-6; a star symbol * appears at the left of the weight display to indicate that the weight value is expanded.

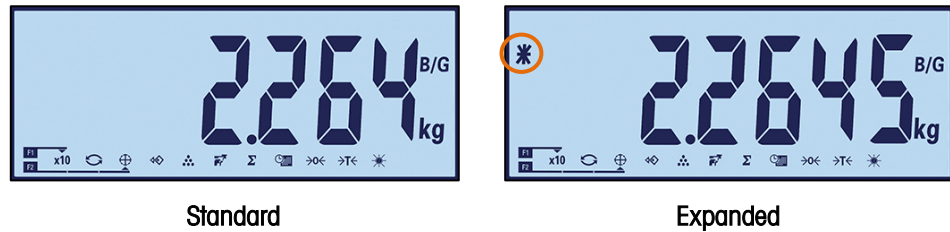

Standard

Expanded

Figure 2-6: Standard and Expanded Weighing Modes

To exit expanded mode, either:

- Wait five seconds; the terminal will automatically return to normal resolution.

Or

- Press the x10 function key again

■ Printing is disabled when the weight is expanded.

2.4.2. Unit Switching

In order to support locations and applications that require multiple measurement units, the IND231/IND236 supports unit switching. This is illustrated in Figure 2-7, which shows the display switching from Kg to g. The SWITCH UNITS function enables switching between primary units (the main unit of measure) and alternate units.

Primary unit is set in the submenu F1.2.1. The second unit is set in the submenu F1.6. More information, please refer to Chapter 3, **Configuration**.



Figure 2-7: Unit Switching: Kilograms to Grams

When the SWITCH UNITS function is assigned to a function key and that key is pressed, the display changes from the primary unit to the second unit. Pressing the function key again returns the display to the primary unit. Each subsequent key press switches between display units.

When units are switched, the units indicator changes to show the selected unit, and the display value is converted. The display division changes to an equivalent weight value in the switched unit

(for example, from 0.02 lb to 0.01 kg) and the decimal location switches to indicate the conversion.

When switching units, the capacity of the converted units is dictated by the original number of divisions established in the capacity and increments area of setup. In some situations, this may reduce the capacity of the terminal when converting to second unit. If switching would result in a value that is not supported by IND231/IND236, the unit switch will not occur.

2.4.3. Date and Time

The Date & Time function key is only used to display date or time. Configure the Date & Time in setup at **F3 - Terminal > F3.3 - Date & Time**. When the function key is first pressed, the time will be shown. A second press displays the date. The third press returns the display to weighing mode. To return directly to weighing mode at any time, press the CLEAR .

2.4.4. Backlight Adjustment

The Backlight Adjustment function key is used to set the brightness of the backlight. There are three options: **off**, **low** and **high**. Each press of the key moves the backlight to the next setting.

2.4.5. Zero

When a function key is set to ZERO, it has the same effect as the dedicated zero key .

The Zero function is used to set or reset the initial zero reference point of the terminal. There are three types of zero setting modes:

- Automatic Zero Maintenance
- Power Up Zero
- Pushbutton Zero

When the scale platform or weighbridge is empty, the terminal should indicate zero. The gross zero reference is recorded during calibration. If pushbutton zero is enabled in configuration and the weight is within the zero range, pressing ZERO will capture a new gross zero reference point.

2.4.5.1. Automatic Zero Maintenance

Automatic Zero Maintenance (AZM) enables the IND231/IND236 to reset to the center of zero in order to compensate for conditions such as terminal or load cell drift or debris on a scale platform. The AZM operating range is selectable from 0.5, 1, 3 or 10 divisions. Within the configured range, when the terminal is in a no motion condition, AZM makes small adjustments to the current zero reading to drive the weight reading toward the true center-of-zero. The feature does not function when the weight is outside the configured AZM range.

2.4.5.2. Power up Zero

Power up Zero enables the IND231/IND236 terminal to capture a new zero reference point after power is applied. If there is a motion during power-up zero capture function, the terminal will continue to check for a no-motion condition until zero is captured.

Power up zero can be disabled or enabled, and a range above and below calibrated zero can be configured. The range is selectable from +/-2%, +/-10% or +/-20% of capacity and can include a positive range and also a range below calibrated zero.

2.4.5.3. Pushbutton Zero

The pushbutton (semi-automatic) zero function can be activated by pressing the ZERO key , by programming a discrete input, or by issuing a serial command.

Any type of semi-automatic zero can be set to +/-2%, +/- 10% or +/- 20%, relative to the calibrated zero point.

The semi-automatic Zero command can be initiated via a discrete input, or an ASCII 'Z' command sent serially (in CPTZ and SICS interface modes).

2.4.6. Tare

When a function key is set to Tare, it has the same effect as the tare key .

Tare is the weight of an empty container. A tare value is subtracted from the gross weight measurement, providing the computation of the net weight (material without the container). The tare function can also be used to track the net amount of material being added to or removed from a vessel or container. In this second case, the weight of the material in the container is included with the tare weight of the container and the display then reflects the net result of any additions to or subtractions from the vessel.

Tare operations in the IND231/IND236 include:

- Automatic Tare
- Clearing Tare
- Tare Interlock
- Keyboard Tare

2.4.6.1. Automatic Tare

The IND231 can be configured so that tare is taken automatically (auto tare) after the weight on the scale exceeds a programmed tare threshold weight. Auto tare can be configured in setup as enabled or disabled. When auto tare is enabled, the display changes to a zero net weight indication after the weight exceeds the threshold value. Auto tare operations involve:

Auto tare threshold Weight	When weight on the scale platform exceeds the tare threshold value, the terminal automatically tares.
Auto tare reset Threshold Weight	The reset threshold weight must be less than the tare threshold weight. When the weight on the scale platform falls below the reset threshold value, such as when a load has been removed, the terminal automatically resets the auto tare trigger.

2.4.6.2. Clearing Tare

Tare values can be cleared manually or automatically.

2.4.6.2.1.

Manual Clear

Manually clear tare values by pressing the CLEAR key  on the keypad when the IND231/IND236 is in the net mode and has completed the weighing operation. Motion on the scale will not impact a manual clear.

If configured in setup, pressing the ZERO scale function key  will first clear the tare, then issue a zero command (see Chapter 3, **Configuration**, the Scale section, Auto Clear).

2.4.6.2.2.

Auto Clear Tare

The IND231/IND236 can be configured to clear tare automatically when the weight returns to zero point. Once the tare is cleared, the display returns to the gross weighing mode.

Auto clear is disabled or enabled in setup. Refer to the **F1.5, Auto Clear** section of Chapter 3, **Configuration**, for further information about configuring auto clear.

Keyboard Tare

Pushbutton tare can be configured in setup as enabled or disabled. When be disabled, pressing the TARE key  has no effect.

If pushbutton tare is enabled, pressing the pushbutton TARE key  initiates a semi-automatic tare. The IND231/IND236 will attempt to perform a tare process. If the process is successful, the display changes to a zero net weight indication and the previous weight on the scale is stored as the tare value. The net symbol will be indicated on the display.

2.4.7.

Print

The print function can be initiated by pressing the Transfer/Print  key or by automatic print settings.

Automatic initiation of a print occurs after the gross weight exceeds the minimum threshold and there is no motion on the scale. After initiation, the gross weight must return below the reset threshold before a subsequent automatic print can occur.

Automatic print may be disabled or enabled. Automatic print can be triggered and reset by weight exceeding thresholds or by weight deviation from a previously stable reading.

2.4.7.1.

Print setting

For more information about the print setting, refer to **Chapter 3, Configuration, Communication**

2.4.7.2.

Printout format

All the printout formats are fixed and cannot be redefined. Depending on the current function status of terminal, a different printout format can be selected. Refer to **Applications** on page 2-11.

2.4.7.3.

Standard Printout

If Tare is zero, the standard printout does not include Tare and Net values.

A star symbol before the weight indicates that the weight is an average, if the current mode is animal weighing.

The single and multi-line outputs appear as follows:

Multi-line output	Date	YYY.MM.DD
	Time	HH:MM:SS
	Gross	XX.XXX Unit
	Tare	XX.XXX Unit
	Net	XX.XXX Unit
Single-line output	Date_YYYY.MM.DD__ Time_HH :MM :SS__ Gross_XXXX.XXX_Unit__Tare_XXXX.XXX_Unit__ Net_XXXX.XXX_Unit	

- Each number includes eight characters, including the decimal point.

2.5. Remote Display Functionality

2.5.1. Introduction

Instead of operating as a normal weight display for an attached weighing platform, the IND231/IND236 can function as a remote display for another METTLER TOLEDO terminal, sending Toledo continuous or SICS output. The keypad on the remote display IND231/IND236 can also be used to issue simple Clear, Tare, Print and Zero commands back to the Master terminal when the appropriate key is pressed.

2.5.2. Setup

2.5.2.1. Physical Connection of Master and Remote Terminals

Communication for the remote display function occurs over a single serial connection configured for RS-232, RS-422 or RS-485 communication. Either serial port in the IND231/IND236 can be programmed to accept serial data from the Master and to send keypad commands back to it, so only a single port is necessary for remote display operation. Thus, if the optional COM2 port is installed, one port can be used for communication with the Master terminal while the other port can be configured to provide a demand output to a local printer.

The serial ports must be identically configured in both the Master and the Remote terminal.

2.5.2.2. Remote Display Configuration

2.5.2.2.1. Mode and Port Selection

In the IND231/IND236 terminal that will function as the remote display terminal, parameter F.1.1.1 (**Scale Type**) must be selected as either rCom1 (if COM1 will be used as the data input port) or rCom2 (if COM2 will be used as the data input port).

Figure 2-8 shows the IND231/IND236 COM1 selected in as the remote display input port.



Figure 2-8: Scale Type Setting for Remote Operation

2.5.2.2.2. Data Format Selection

When **Scale Type** is set to rCom1 or rCom2, a new parameter F1.1.3 is shown which allows selection of the data format used for the communication. The two possible choices are Toledo continuous or SICS, as shown in Figure 2-9.

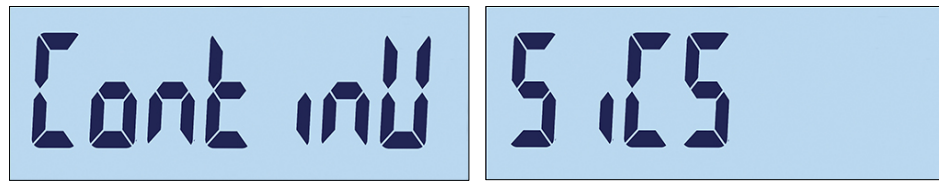

Figure 2-9: Connection Configured for SICS and Toledo Continuous Data

2.5.2.2.3. Port Parameter Selections

Finally, the serial port parameters must be configured in F4.x.3, where "x" is either "1" for COM1 or a "2" for COM2. The baud rate, data bits and parity selections must be the same in both terminals. Recommended settings are:

Table 2-6: Serial Port Parameters

Parameter	Value
F4.x.3.1 (baud rate)	9600
F4.x.3.2 (data bits / parity)	8 nonE
F4.x.3.3 (flow control)	oFF

2.5.2.3. Master Terminal Configuration

The Master terminal port used to connect to the remote display terminal must be configured to send weight information either as Toledo Continuous output or as SICS, and this must match the selection in the remote display terminal. It is not possible to send a demand print from the master terminal to the remote terminal.

The serial port parameters for baud rate, data bits and parity must match those selected in the remote display IND231/IND236. Refer to Table 2-6 for the recommended serial port parameters.

Figure 2-10 shows a typical Remote Display configuration, with the Master terminal able to receive commands sent from the remote IND231/IND236.

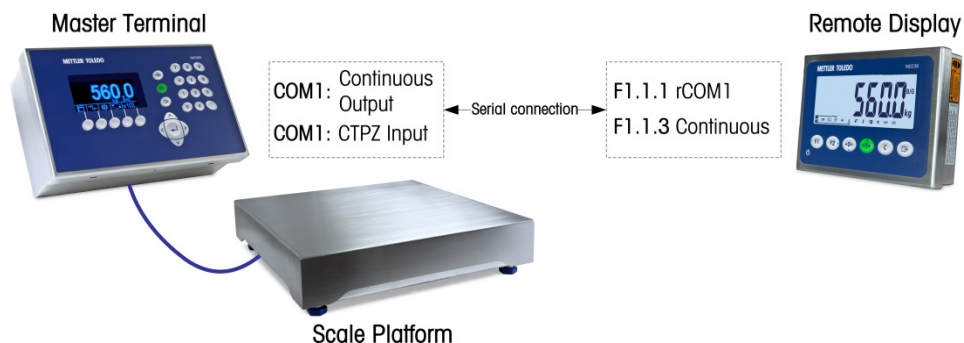

Figure 2-10: Example of Terminal Configuration for Remote Display Function

If the keypad of the remote display will be used to send CLEAR, TARE, PRINT and ZERO keypad commands back to the Master terminal, then the Master terminal port must support CTPZ command input (if the Toledo Continuous mode was selected) or TAC, T, PRN and Z commands (in SICS mode). When the SICS interface is used, only the SICS commands recognized by the Master will operate properly from the remote display keypad.

2.5.3. Remote Display Operation

2.5.3.1. Toledo Continuous Operation Overview

Upon power-up, the Master terminal will automatically begin to send weight data to the remote display IND231/IND236. The remote terminal will display the weight as sent from the Master terminal.

When any of the remote terminal's three scale function keys (CLEAR, TARE and ZERO) is pressed, the corresponding ASCII character is transmitted to the Master terminal. The Master terminal will then act upon the command as appropriate. For example, if the ZERO key is pressed on the remote display a "Z" command is sent to the Master terminal. If the Master terminal is outside of its zero capture range, it will indicate an error on its display but no message is communicated back to the remote display. The remote display simply sends the ASCII command corresponding to the key pressed and it is up to the Master to perform the request or not. The F1 and F2 keys do not send commands to the Master terminal.

2.5.3.2. SICS Operation Overview

Upon power-up, the remote display will automatically begin asking the Master terminal to send displayed weight and tare weight information using the SI and TA commands. When the Master terminal receives these commands, it will respond by sending the displayed weight and tare weight value to the remote display IND231/IND236. The remote display will display the weights as sent from the Master terminal.

When any of the three scale function keys (CLEAR, TARE and ZERO) is pressed on the remote display, the corresponding SICS command is transmitted to the Master terminal. The Master terminal will then act upon the command as appropriate. When using SICS, the Master terminal will always send the status of a command back to the remote display. The status will indicate success or failure of the command. The F1 and F2 keys do not send commands to the Master terminal.

The remote display will evaluate the Master terminal's response. If the Master terminal was not able to complete the command successfully, the remote terminal will display `--n 0--` for about 3 seconds.

For example, if the ZERO key is pressed on the remote display, a "Z" command is sent to the Master terminal. If the Master terminal is above its zero capture limit, it will respond with an E + back to the remote display. This is one of 4 possible responses for the ZERO command in SICS. The remote terminal will display `~n 0~`, indicating that zero could not be accomplished because the weight was over the maximum limit.

2.5.3.3. Print Key Operation in Continuous and SICS Modes

The operation of the PRINT key depends upon programming in the remote display terminal:

- If the optional serial port is present, whichever port in the remote display is not programmed to operate with the Master terminal can be programmed for Print. In this case, a local print with the selected format will be created at the remote display. Nothing is sent to the Master terminal.
- If the remote display does not have a port assigned to Print, pressing PRINT sends an ASCII P (continuous mode) or an ASCII PRN (SICS mode) command to the Master terminal. It is then up to the Master terminal to carry out the print function.

2.5.3.4. Limits of Operation

When the IND231/IND236 is in its remote display mode, it does not support discrete I/O or unit switching.

All the application modes of the standard IND231/IND236 are supported when operating in the remote display mode. Checkweighing, counting, animal weighing and totalization are fully functional based on the weight value received from the Master terminal. The additional features of target recall and time and date are also available for local use at the remote display.

The IND231/IND236 remote display mode supports g, kg, lb and oz weight units from the Master terminal. If weight units other than these are selected in the Master terminal, the weight value will be displayed, but the remote display will not show a weight unit.

2.6. Applications

Each of the five applications can be accessed by pressing the configurable FUNCTION keys. When the key is pressed, the terminal will leave basic weighing mode and enter whichever application mode is configured in setup at **Function Key > Assignment**. Press the  key to exit the application and return to basic weighing mode.

Once an application has been started, only active function keys' symbols are displayed.

2.6.1. Checkweighing

The Checkweighing application provides the ability to compare current weight on the scale to a stored target weight and indicate the comparison status on the display.

The IND231/IND236 display indicates the Over/Under status graphically in the status line at the top of the screen. Three discrete outputs can be configured for control of external lights or a similar device, to indicate the current status of the weight comparison.

2.6.1.1. Configuration

Checkweighing only can be started from basic weighing or in the checkweighing application. Whenever another function is active, such as counting, X10, or animal weighing, checkweighing cannot be started and a warning message “—no—” (Figure 2-11) will appear for a short time.

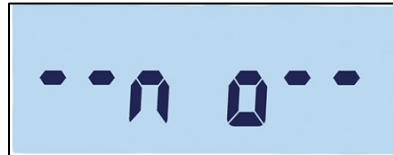



Figure 2-11: “NO” Symbol











The  symbol in the top line indicates the checkweighing status.

To configure checkweighing:

1. Set the checkweighing target (absolute value only).

Example:

Target weight = 5.000kg
 Tolerance + = 1.000kg
 Tolerance - = 1.000kg

2. Press  or  (whichever is assigned to Checkweighing) to enter the target editing screen.  will appear at the top of the screen. If there is stable weight on the platform, it will be detected as an original target value. “- - - - -” indicates that the terminal is attempting to detect a stable weight. The target can be selected in one of two ways:
 - a. If a stable weight is detected before the approximately 0.5 second timeout elapses, “target” will appear for one second, then the detected stable weight will display.
 - b. Otherwise, the terminal will show “Target” for 1 second, and then display zero weight (Figure 2-12). Select a digit to edit using  to move left and  to move right. Once the required digit is selected and blinking, its value can be increased using  and decreased using . In the example shown in Figure 2-12, the target has been set to 3 kg. Press  to accept this current value as the target and move to the next screen, “Tolerance -”.
3.  appears at upper left in the display. Set the using the direction keys, as indicated in step 2.b, above. In this example (Figure 2-12, center), the low tolerance is set to 1 kg. Press  to move to the next screen, “Tolerance +”.
4.  appears on the top of the screen. Set the using the direction keys, as indicated in step 2.b, above. Here (Figure 2-12, right), the high tolerance is set to 1 kg.

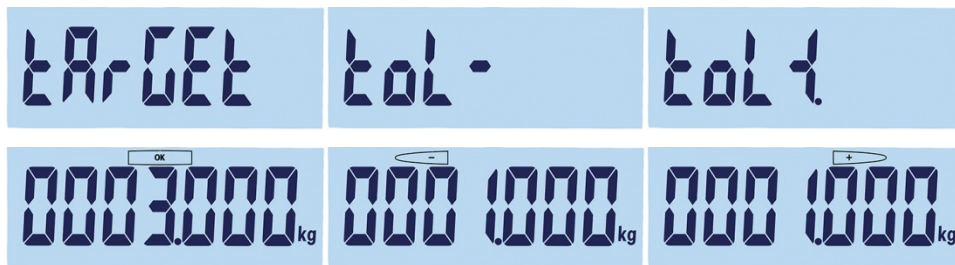

Figure 2-12: Target and Tolerance Displays: Target (left), Low (center) High (right)

2.6.1.2. Procedure

To perform checkweighing:

1. Press **F1** or **F2** (whichever is assigned to Checkweighing) to enter the checkweighing screen. The weight status is indicated as follows (based on the configuration set in the Configuration section, above).
 - **Under** Below 4kg; (Figure 2-13, left)
 - **OK** Between 4kg and 6kg ;(Figure 2-13, center)
 - **Over** Above 6kg ;(Figure 2-13, right)



Figure 2-13: Over, OK and Under Displays

2. Once checkweighing is completed, press **C** to exit the application and return to basic weighing.

2.6.1.3. Viewing Configured Values

When in the checkweighing application, press and hold the Target function key to view the current active **target**, **tol-** and **tol+** values. The information will display for one second, then the target value will appear together with **OK**. Press the "Target" key repeatedly to cycle through the three checkweighing values – OK, low tolerance and high tolerance. Press **C** to exit.

2.6.1.4. Over/Under Printout

If Tare is zero, Tare and Net values are not printed.

The single and multi-line outputs appear as follows:

Multi-line output	Date	YYY.MM.DD
	Time	HH:MM:SS
	Target	XXXX.XXX Unit
	Tol +	XX Unit

Tol -	XX Unit
Gross	XXXX.XXX Unit
Tare	XXXX.XXX Unit
Net	XXXX.XXX Unit

Single-line output

```
Date_YYYY.MM.DD__ Time_HH :MM :SS__ Tare
_XXX.XXX_Unit__ Tol+_XX_%__ Tol-XX_%__ Gross
_XXX.XXX_Unit__ Tare _XX.XXX_Unit__
Net_XXX.XXX_Unit
```

2.6.2. Target Recall

Target recall is a function used to perform checkweighing using values from a database. Up to 10 over/under sets of data are available for easy recall on the terminal display. Each set includes data such as record number, target value, tolerance - value, tolerance + value and tare value.

The record parameters are set via menu setting F2.2. For more information, please refer to Chapter 3, **Configuration**.

2.6.2.1. Operation

When the RECALL function key is pressed, the message shown in Figure 2-14 will be displayed briefly. Then, if the database is not empty, the first record in it will appear (Figure 2-15). Otherwise, "EMPTY" (Figure 2-16) will display, and then the weight display will reappear.





Figure 2-14: Target Database Recall Message



Figure 2-15: Record 01 Message



Figure 2-16: Target Database Empty Message

Use the  and  keys to select the required record, then confirm the selection by pressing the  key. The checkweighing display will appear, with the selected values set, and the checkweighing procedure can begin.

In checkweighing mode, pre-defined parameters can be viewed by pressing and holding the RECALL key. Each subsequent press of the RECALL key displays in turn parameter values for **target**, **tolerance -** and **tolerance +**.

2.6.3. Counting

The IND231/IND236 counting application provides a simple counting sequence that guides an operator through a sampling process to determine a count value.

2.6.3.1. Operation

Counting only can be started from basic weighing or in the counting application.

2.6.3.1.1. Procedure

To count pieces:

1. Press the counting function key . "SAMPLE" will be displayed, then "PCS 05", as shown in Figure 2-17.

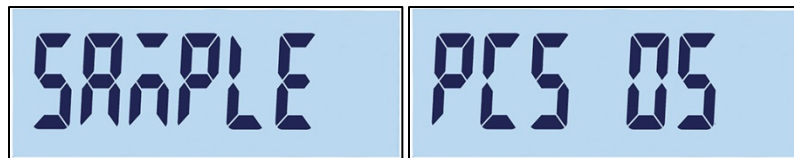





Figure 2-17: Reference Number

2. The reference number can be adjusted using  (decrease) and  (increase) keys. Selections are 5, 10, 20, 50 and 100.
3. Confirm the reference number by pressing . "-----" will display (Figure 2-18) while the scale detects stable weight. Make sure that the number of samples on the scale matches the selected reference size. If stable weight is detected before the process times out, the counting application starts; otherwise the screen remains in the previous weighing state.

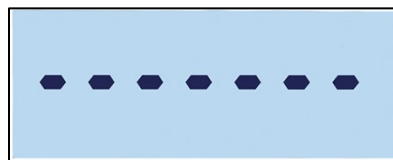

Figure 2-18: Detecting Stable Weight

4. Load the parts to be counted. The count will be displayed (Figure 2-19).

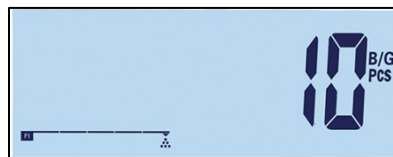



Figure 2-19: Piece Count Display

5. When counting is complete, press  to exit the checkweighing application and return to the basic weighing interface.

2.6.3.1.2. Reviewing Average Piece Weight

When the counting mode is active, press and hold the counting function key to display the current APW (Average piece weight). The APW symbol  will appear in the top row of the display, and the APW value – in Figure 2-21, the value is 0.015 kg.



Figure 2-20: APW Review Screen

Press the counting function key again to display the reference number Figure 2-21 – here, 100 pieces is the current selection.

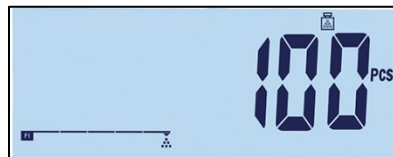



Figure 2-21: Reference Number Review Screen

Each time the “counting” key is pressed, the display switches between APW and reference number. Press the  key to exit the review screens.

2.6.3.1.3. Unit switch in counting mode

When the counting application is active, the unit switch has a special function unlike its standard operation. Press the “Unit Switch” key to cycle the display through PCS, primary unit and second unit in turn.

2.6.3.2. Counting Printout

If Tare is zero, Tare and Net values are not printed.

The single and multi-line outputs appear as follows:

Multi-line output	Date	YYY.MM.DD
	Time	HH:MM:SS
	Pieces	XXXXXXXXX Unit
	APW	XXXX.XXX Unit
	Gross	XXXX.XXX Unit
	Tare	XXXX.XXX Unit
	Net	XXXX.XXX Unit
	Single-line output	Date_YYYY.MM.DD_ Time_HH :MM :SS_ Pieces_XXXXXXXXX_PCS_ APW_XXXX.XXX_Unit_ Gross_XXXX.XXX_Unit_ Tare_XXX.XXX_Unit_ Net_XXXX.XXX_Unit

2.6.4. Animal Weighing

The animal weighing application provides the ability to calculate and display an average weight value determined over a user-defined sampling period. This is useful when the weight is constantly unstable, as is the case when weighing live animals.

The weighing mode can be configured in setup. If auto mode is selected, the animal weighing will start automatically when there is load on the scale. In manual mode, the animal weighing must be started by pressing the function key.

2.6.4.1. Operation

Animal weighing can only be started from basic weighing mode. Otherwise, “—no—” (Figure 2-11) will be shown.

The animal weighing application has a net weight threshold of 9d. When the weight put on the platform exceeds 9 weight divisions (based on the division size configured in setup), the application will start. When either the net or gross weight is below 9d, the application will reset in preparation for the next weighing.

1. Put the animal/s on the platform, then press the “animal weighing” function key . While the terminal collects weight values, “-----” is displayed (Figure 2-22). The process takes 2 to 3 seconds. In order to achieve better precision, the first 14 weight values are discarded, and the next 56 values collected for use in the calculation.

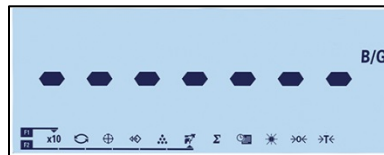



Figure 2-22: Display Indicating Weight Value Collection in Progress

2. The average weight will be displayed, together with a star symbol, as shown in Figure 2-23.



Figure 2-23: Animal Weight Value Displayed

3. To complete the current weighing, either remove the weight from the platform or press the clear key . Tare will also be cleared.

2.6.4.2. Animal printout

The single and multi-line outputs appear as follows:

Multi-line output	Date	YYY.MM.DD
	Time	HH:MM:SS
	Average G	XX.XXX Unit
	Tare	XX.XXX Unit
Single-line output	Date_YYYY.MM.DD_ _Time_HH :MM :SS_ _Average G_XXXX.XXX_Unit_ _Tare_XXXX.XXX_Unit_ _ Average n_XXXX.XXX_Unit	

- Each number includes eight characters, including the decimal point.

2.6.5. Accumulation

For many weighing applications, knowing how many transactions were performed and how much material was processed during a particular period of time is useful information.

The IND231/IND236 terminal provides grand total (GT) registers and counters. Counters have a limit of 999 and registers will accumulate up to 7 digits of weight, including any digits to the right of the decimal point. For example, a scale programmed for 500 x 0.1 kg will accumulate weight values up to 999999.9 (7 total digits). If either of these limits is exceeded, an error message “—no—” will display and the totals must be reset before additional weights or counts are added.

2.6.5.1. Operation

Accumulation can only be started when the terminal is in basic weighing mode. If one of the applications is active, , “—no—” (Figure 2-11) will be shown.

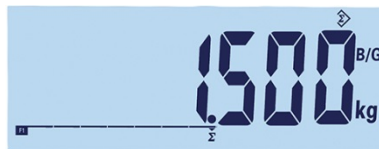

Figure 2-24: Collecting value symbol

The procedure for accumulation is as follows:

1. Put the first weight on the platform and press the “accumulation” function key Σ . If the stable weight is detected within 2 seconds, the grand total value will be 1.5 kg and number will be 1 (Figure 2-24).
2. Each time the new weight is put on the platform, press the accumulation key to add the new value to the total.
3. Press and hold the function key to display the total value (Figure 2-25, left). Note that when the accumulation or count is displayed, the Accumulation icon Σ will blink. Press the function key briefly, and the “Count”, or number of values appears (Figure 2-25, right). Each time the “accumulation” key is pressed, the display will switch between count and sum.

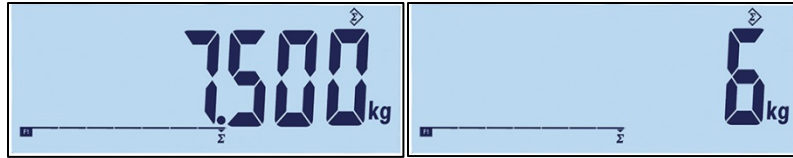



Figure 2-25: Collecting value symbol

4. Press the  key to exit accumulation and return to basic weighing mode.

2.6.5.2.

Accumulation Printout

When the terminal is in accumulation mode and the print key  is pressed, the printed total accumulated weight will include the terminal's currently displayed net value.

The single and multi-line outputs appear as follows:

Multi-line output	<table border="0"> <tr><td>Date</td><td>YYY.MM.DD</td></tr> <tr><td>Time</td><td>HH:MM:SS</td></tr> <tr><td>Total</td><td>XX.XXX Unit</td></tr> <tr><td>Count</td><td>XXXX.XXX</td></tr> <tr><td colspan="2"> </td></tr> <tr><td>Gross</td><td>XXXX.XXX Unit</td></tr> <tr><td>Tare</td><td>XXXX.XXX Unit</td></tr> <tr><td>Net</td><td>XXXX.XXX Unit</td></tr> </table>	Date	YYY.MM.DD	Time	HH:MM:SS	Total	XX.XXX Unit	Count	XXXX.XXX			Gross	XXXX.XXX Unit	Tare	XXXX.XXX Unit	Net	XXXX.XXX Unit
Date	YYY.MM.DD																
Time	HH:MM:SS																
Total	XX.XXX Unit																
Count	XXXX.XXX																
Gross	XXXX.XXX Unit																
Tare	XXXX.XXX Unit																
Net	XXXX.XXX Unit																
Single-line output	<pre>Date_YYYY.MM.DD_ Time_HH :MM :SS_ Total_XXXX.XXX_Unit_ Count_XXXX.XXX_ Gross_XXXX.XXX_Unit_ Tare_XXX.XXX_Unit_ Net_XXXX.XXX_Unit</pre>																

3 Configuration

This chapter covers

- Accessing Setup Mode
- Setup Menu Structure
- Configuration Overview
- F1 Scale
- F2 Application
- F3 Terminal
- F4 Communication
- F5 Maintenance

This chapter provides information about how to configure the IND231/IND236 terminal. It describes access to the setup menu where functions can be enabled, disabled, or defined by entering parameter values.

The menu consists of the following blocks:

F1	Scale	F4	Communication
F2	Application	F5	Maintenance
F3	Terminal		

3.1. Accessing Setup Mode

3.1.1. Entering Setup Mode

The configuration of the IND231/IND236 terminal is accessed by pressing and holding the MENU key .

A login screen (Figure 3-1) displays and the user must enter the correct password in order to advance into setup.



Figure 3-1: Login Screen

Access to items in setup is controlled by a password. **Error! Reference source not found.** shows which parts of the setup tree are accessible to a user logged in using the Supervisor password.

Table 3-1: Passwords and Access Levels

	Password	F1.1.2 = Approved	F1.1.2 = None
Supervisor		F1.6 (second unit), F2, F3, F4; F5.2 (statistics); F5.8 (print configuration)	

To enter a password:

1. When the login screen displays, use the scale function keys to enter the password (**Error! Reference source not found.**).

2. Press the  key. If the password is correct, the terminal will enter setup mode, and the setup menu will be displayed. If the password is not valid, the display returns to the weighing mode.
 - If the terminal is configured as legal for trade, the user can only access setup by pressing the setup-switch (a hardware switch on main-board, indicated in Figure 3-2). The terminal will then display the F1 (Scale) menu label and scale parameters can be modified.

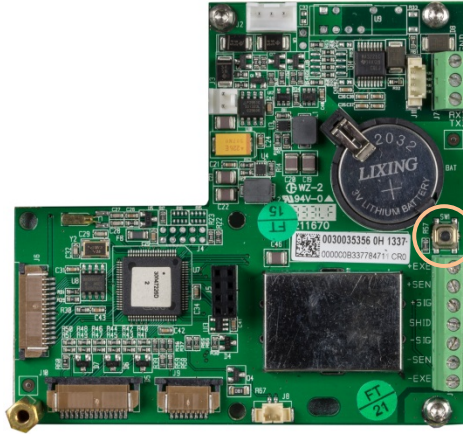



Figure 3-2: Setup Switch Location on Terminal Main Board

3.1.2. Exiting Setup Mode

To exit the setup mode and return to the weighing mode:

1. Press the  key, or left  when in the root of the menu tree (F1, F2, etc. displayed). A message will appear asking whether to Abort or Save changes Figure 3-3.

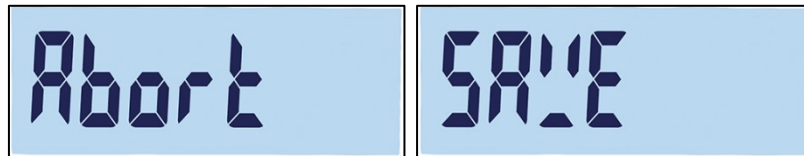











Figure 3-3: Prompts When Exiting Setup

2. Use  (down) and  (up) to switch between **Save** and **Abort**.
 - **Save:** Save the setup parameters.
 - **Abort:** Do not save the setup parameters.
3. Once the selection has been made, there are two options:
 -  or  Confirm choice of Save or Abort, and exit to main screen.
 -  Remain in the setup menu, at F1.

3.1.3. Setup Menu Navigation

3.1.3.1. Key Functions

After entering setup, the F1, F2, Zero and Tare keys become navigation keys, and are used to move around in the menu structure and to adjust settings once a parameter settings screen has been reached.





		Menu Structure	Settings Screen
	Left	Back to next higher menu screen	Return to menu structure <i>or</i> , if a numerical entry screen, Move focus left
	Right	Access next lower submenu screen	Accept current value and return to menu structure <i>or</i> , if a numerical entry screen, Move focus right
	Up	Move to next higher screen at current level	Next higher value for item in focus*
	Down	Move to next lower screen at current level	Next lower value for item in focus*



















* Parameters with discrete settings (such as **On/Off** or **0.5, 1, 10**) cycle through settings in either Up or Down direction.

3.1.3.2. Example of Navigation

Each screen of the setup menu tree can be reached using the keys above. The example shown in Table 3-2 shows how to access the **Scale Approval** screen (F1.1.2) and set an approval, then active the **Tare Interlock** feature (F1.5.2), and finally exit setup, either saving or discarding these changes.

Table 3-2: Accessing and Setting Parameters

Key	Display	Action
n/a	F1	Setup has been accessed
	F1.1	Move one level lower in menu structure
	F1.1.1	Move one level lower in menu structure
	F1.1.2	Move to next branch at this level
	noNE	Display Approval setting screen
	oiML	Select OIML approval

Key	Display	Action
 	F1.2	OIML accepted, focus moved to F1.2 submenu Note: Either Right (F2) or Enter key accepts the selection
	F1.3	Move to next main sub-branch
	F1.4	
	F1.5	
	F1.5.1	Move down to next lower level
	F1.5.2	Move to next branch at current level
	off	Current Tare Interlock setting displayed – OFF
 	on	Tare Interlock set to ON Note: Either Up or Down key will cycle through ON/OFF values
 	F1.5.3	ON accepted, focus moved to next branch at this level Note: Either Right (F2) or Enter key accepts the selection
	F1.5	Return to top level of menu
	F1	
	SAVE	Exit from setup – SAVE prompt displays
	Returns to weighing display	
 	Abort	Discards changes, returns to weighing display

3.1.3.3. Setting Numbers

When setting a numerical parameter such as Capacity (F1.2.3), the Left and Right navigation keys function to move focus, and the Up and Down keys adjust the value. The number in focus blinks:

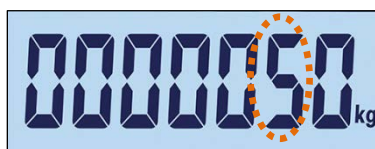







Figure 3-4: Changing Numerical Values, Digit in Focus Blinking

To increase the value, press ; to decrease it, press . To select the units column, press ; to select the hundreds column, press . To accept the displayed value and exit the screen, press .

3.2. Setup Menu Structure



3.2.1. Main setup menu

When setup is entered, Block F1 is displayed as shown in Figure 3-5. Direction keys can be used to select different menu blocks (From F1 to F5).



Figure 3-5: F1 Menu Screen

3.2.2. Configurable function keys

The function keys can be configured without entering setup. From the main screen, press and hold either function key F1 or F2 to enter the configuration display shown in Figure 3-6. Use the Down  and Up  keys to select the function for that key. In the example shown, F1 is set to x10 and F2 is set to Accumulation (Σ).

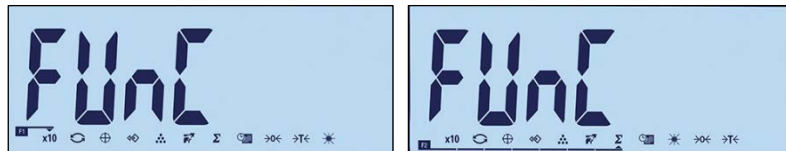

Figure 3-6: Setting Assignments for Function Keys F1 and F2

3.3. Configuration Overview

Figure 3-7 shows all the main branches of the terminal’s configuration menu, except branches that are application-specific.

Details for each of the five major setup branches are provided in the sections following the overview. Use this information to program the basic configuration of the IND231/IND236 terminal.

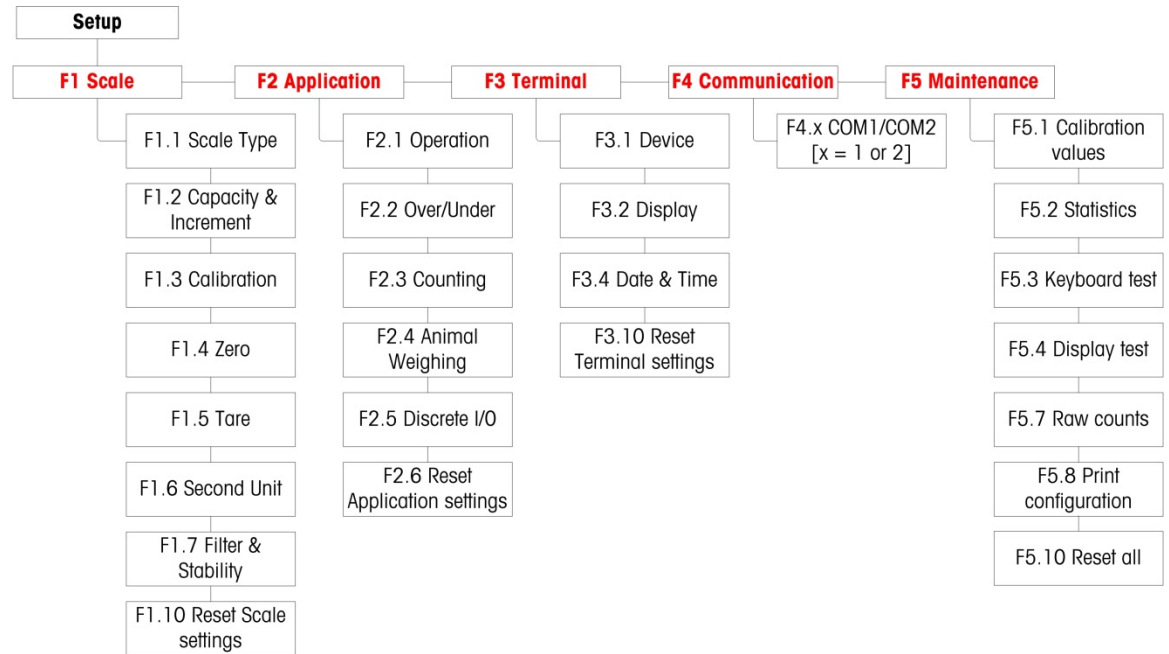

Figure 3-7: IND231/IND236 Setup Menu Structure

- An invalid entry during calibration will cause a `--n 0--` message to appear. The message will disappear after about three seconds, and the display will return to its previous state.

3.4. F1 Scale

Figure 3-8 shows a detailed view of the parameters available in the Scale branch of the setup menu. Each of these parameters is described in this section.

- If the terminal is approved (at F1.1.2), only F1.6 will be available for editing. To access other parameters in the Scale branch, the metrology switch (refer to page 3-1) must be pressed.

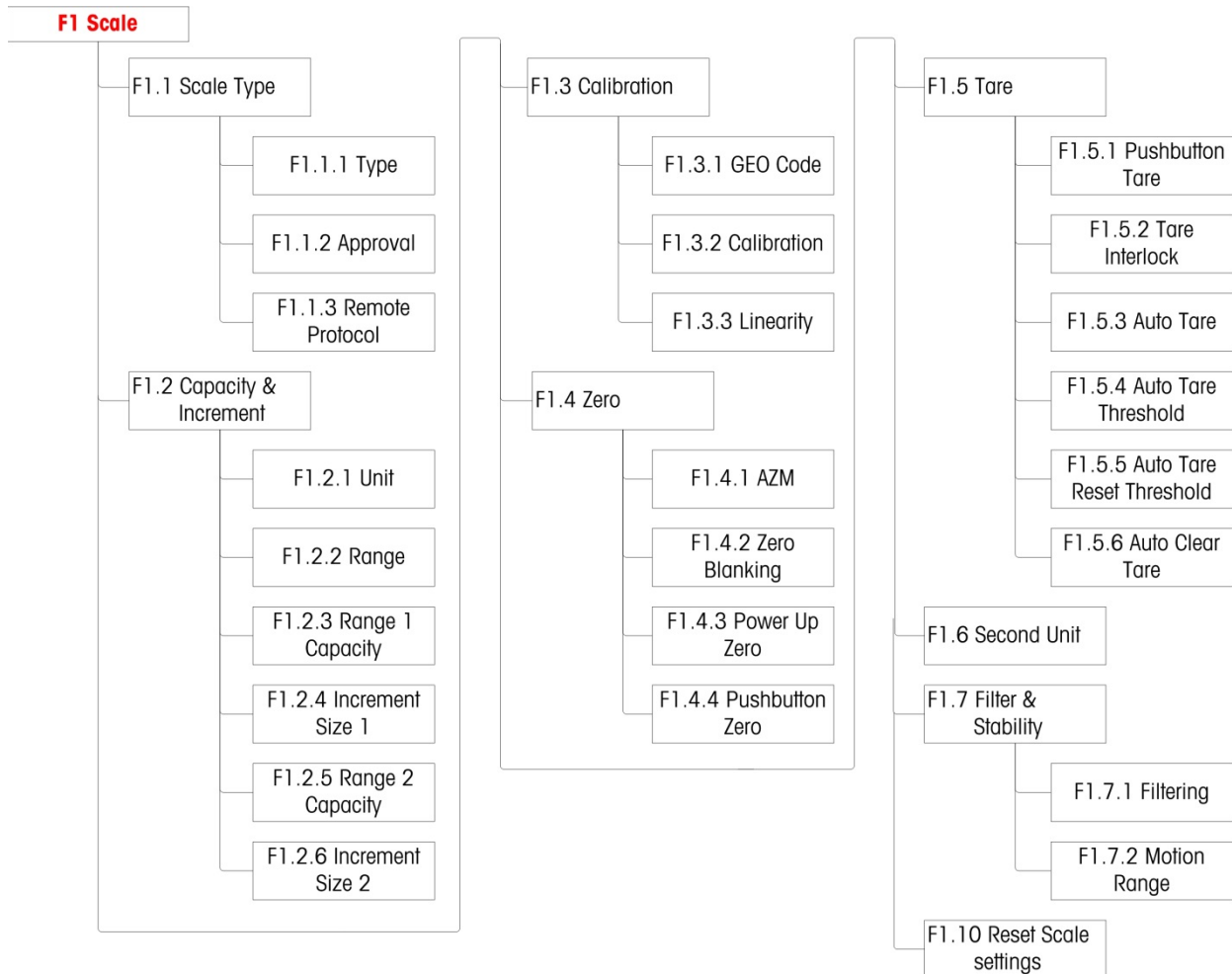

Figure 3-8: Scale Menu Structure

3.4.1. F1.1 Scale type

The Scale type setup screen is used to configure the terminal as either a weighing terminal or as a second display, and to configure the Weights and Measures setting.

3.4.1.1. F1.1.1 Type

Selections for Scale Type are:

SCL
(Factory setting)











If scale type is **SCL**, the terminal functions as a scale terminal. If scale type is rCom1 or rCom2, the terminal is used as a second (remote) display. In this case, use the Com 1 or Com 2 port to connect another scale terminal.

When either **rCom 1** or **rCOM 2** is selected, the port mode and print setting for that port (refer to the section beginning on page 3-33) will be hidden, since the port cannot be assigned to any function other than the terminal's connection as a remote display.

3.4.1.2. F1.1.2 Approval

Approval refers to the configuration of metrological (weights and measures) approvals for the specific scale. Options are:

None No approval required	
OIML	
NTEP	
AR	
SRI	

If an approval for **NTEP**, **OIML** or **Sri Lanka** is configured, access to metrological parameters in the Scale setup branch will be limited to F1.6 (units) and F1.10 (Reset scale settings) As Figure 3-9 shows, pressing and holding the  key will first display the type of approval, then prompt for a password, and then display the F1 label.

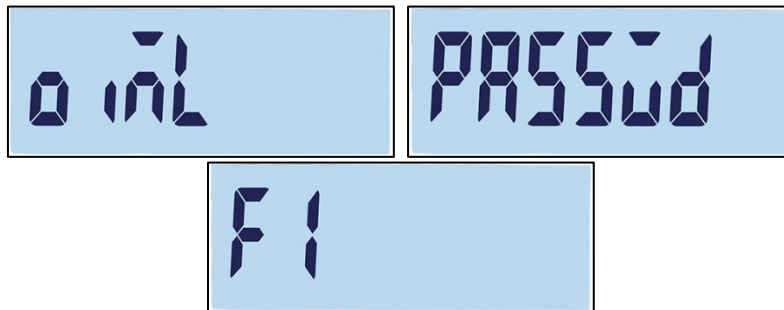

Figure 3-9: Menu Limited to View Only

If the approval is configured for Argentina, access to the entire setup menu is prohibited. If an attempt is made to access the setup menu, an error message will display: "Error 11".

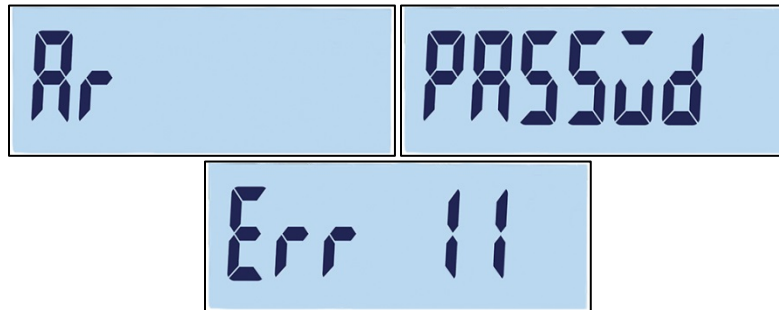

Figure 3-10: Menu Access Prohibited

Access to Setup in an Approved Terminal

To regain access to the F1 setup menu, it is necessary to open the terminal's enclosure and press the metrology switch (refer to **Main Board Wiring Connections** in Appendix A, **Installation**). The terminal will display the F1 Scale settings menu, and scale parameters can be configured.

3.4.2. F1.2 Capacity and Increment

Use the Capacity and Increment setup screen to select primary units, set the number of weighing ranges, and the scale capacity and increment size.

3.4.2.1. F1.2.1 Primary Units

Selections for Primary Units are:

Kilograms (kg) [default], Grams (g), Pounds (lb), Ounces (oz)

3.4.2.2. F1.2.2 Ranges

The terminal can be configured with one or two ranges. If two is selected, the increment size will change when the weight reaches the second range.



Figure 3-11: Range Menu Screen, and Settings

3.4.2.3. F1.2.3 Range 1 capacity

The weight capacity for range 1 can be set to any value from 1 to 500,000. If only one range is enabled, this value will be the scale capacity and the display will show an overcapacity graphic if the weight exceeds the value by more than five increments.

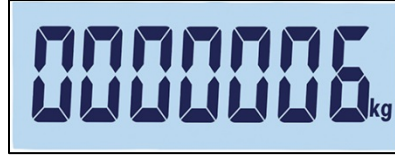

Figure 3-12: Range 1 Capacity

If two ranges are enabled, this will be the weight at which the increment size changes from the range 1 increment size to the range two increment size.

3.4.2.4. F1.2.4 Increment Size 1

F1.2.4 specifies the increment size for range 1. The terminal will automatically generate valid increment size selections, depending on the resolution setting (1000~30,000). Select the appropriate value. If only one range is enabled, this will be the increment size for the entire weighing range of the scale. If two ranges are enabled, this will be the increment used in the lower range.



Figure 3-13: Range 1 Increment

3.4.2.5. F1.2.5 Range 2 capacity

If only one range is enabled, this parameter will not be shown. If two ranges are enabled, the weight capacity for range 2 can be set to any value from 1 to 500,000. This value will be the scale capacity, and the display will show an overcapacity graphic if the weight exceeds the value by more than five increments. Range 2 capacity should be larger than range 1.

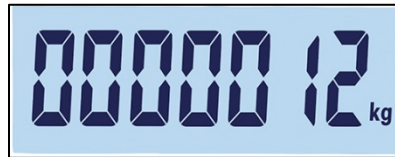

Figure 3-14: Range 2 Capacity

3.4.2.6. F1.2.6 Increment Size 2

F1.2.6 specifies the increment size for weighing range 2. If only one range is enabled, this parameter will not be shown. The terminal will automatically generate valid increment size selections depending on the resolution setting (1000~30,000). Select the appropriate value. This will be the increment used in the upper range.





Figure 3-15: Range 2 Increment

- When multiple ranges are configured, the range 2 increment must be larger than the increment of range 1.

3.4.3. F1.3 Calibration

The Calibration menus allow the entry of GEO code and linearity adjustments and the calibration of zero and span settings.

3.4.3.1. F1.3.1 GEO Code

Use the down  or up  keys to enter the GEO code (0 – 31; refer to Appendix D, **GEO Codes**) for a list of geographical locations and the corresponding codes.

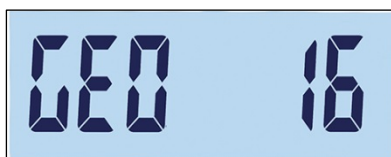
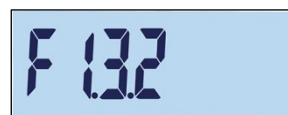



Figure 3-16: GEO Code Value Selection Screen

3.4.3.2. F1.3.2 Calibration

Select F1.3.2 to set zero and full capacity calibration values.

1. Access the Calibration menu.



2. Empty the scale and press  to start calibration. "E SCL" (empty scale) appears on the display. Press  again. The display will count down 10...0 as the terminal captures zero.



3. "Full Ld" appears on the display.

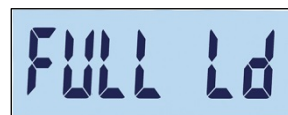

4. Press . The **full capacity** value appears, blinking. Use the down  or up  keys to change the calibration weight value.

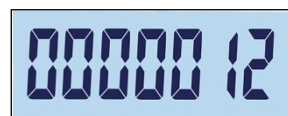

- When the value has been set, put the corresponding full capacity weight on the scale and press . The display will count down 10...0. If the calibration was successful, "done" will display for 2 seconds.



- Best accuracy will be achieved by using the maximum rated capacity of the scale when calibrating full capacity.



3.4.3.3.

F1.3.3 Linearity

Select F1.3.3 to include a linearity adjustment in the calibration. In this case, zero, half- and full-capacity are calibrated.

- Access the Linearity Adjustment menu.



- Empty the scale. Press  to start calibration. "E SCL" (empty scale) appears on the display. Press  again. The display will count down 10...0 to capture zero.



- "ADD LD" appears on the display.

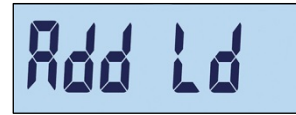

- Press . The **half capacity** value appears, blinking. Use the down  or up  keys to change the calibration value.

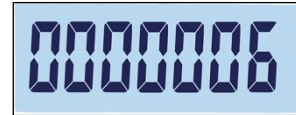

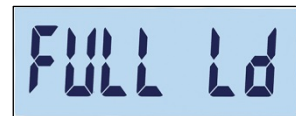

- Put the corresponding half capacity weight on the scale and press . The display will count down 10...0 as the calibration is performed.

- "Full Ld" appears on the display.

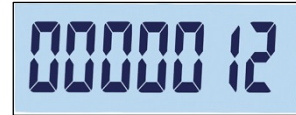

- Press . The **full capacity** number appears, blinking. Use the down  or up  keys to change the calibration value.



- Put the corresponding full capacity weight on the scale and press . The display will count down 10...0. If the calibration was successful, "done" will display for 2 seconds.



- Best accuracy will be achieved by using the maximum rated capacity of the scale when calibrating full capacity.

- If the scale is not stable after 30 seconds, it will time out and display an error code “Error 35” (Figure 3-17, left). This message will display for 2 seconds, and then the terminal will return to the last operation. Either reload the weight, or press  to cancel the process. If calibration is cancelled, “Abort” (Figure 3-17, right) will display briefly, calibration will end, and the F1.3.3 screen will reappear.

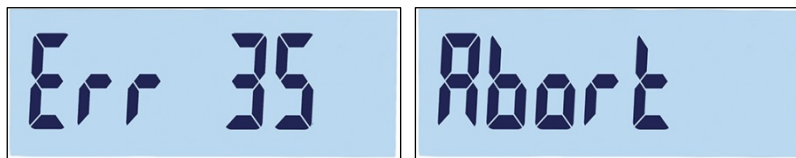

Figure 3-17: Linearity Calibration Error and Abort Messages



- To interrupt the process and save the previous parameters, press  during the calibration. “donE” (Figure 3-18) will appear briefly. The former parameters are saved and the display returns to the F1.3.3 screen.



Figure 3-18: Linearity Calibration Interrupted

- To abort the process without saving the previous parameters, press the power button  during the calibration. “Abort” (Figure 3-17, right) will appear briefly. Calibration is suspended, the former parameters aren’t saved, and the display returns to the F1.3.3 screen.

3.4.4. F1.4 Zero

Zeroing corrects the influence of the accumulation of a small amount of debris on the load plate. This section provides access to Auto Zero Maintenance (AZM) settings, under zero blanking, power-up zero, and pushbutton zero parameters.

3.4.4.1. F1.4.1 Automatic Zero Maintenance (AZM)

Automatic Zero Maintenance (AZM) is a means of tracking zero when the scale is empty. It enables IND231/IND236 to compensate for conditions such as terminal or load cell drift or debris on a scale platform by setting itself back to the center of zero.

Available selections are based on resolution. In scales not approved for trade, selections are:

off, **0.5d** [default value], 1d, 3d, 10d

In approved scales, the only setting is **0.5d**.



Figure 3-19: AZM Value Selection Screen

3.4.4.2. F1.4.2 Zero Blanking

In certain countries, such as Thailand, the approval authorities require the terminal to behave in a particular way when an underload (weight value below zero) is detected, and when a valid weight is detected after an underload. Selections for underload behavior are as follows:

oFF, **20d** [default], 20dZero

These settings function as follows:

- Off The display will continue to display negative gross weights with no limit.
- 20d The underload symbol is shown for values below -20d. As soon as the weight value exceeds -20d, the weight value is displayed again.
- 20dZero The warning "Err 10" will be shown as soon as the weight decreases below -20d. This warning message stays on the screen until the scale is switched off or a zero is performed. Only if this zeroing is successful (within the valid zero setting limits when pressing zero key or within the valid power up zero limits when switching the device off/on) the weight value is shown again. If not, the warning appears again.

3.4.4.3. F1.4.3 Power Up Zero

When Power Up is set to **Off**, the terminal will save and reuse the last zero reference weight after a power cycle, so that it returns to the same gross or net weight value.



Figure 3-20: Power Up Zero Value Selection Screen

When a power up range of **+/-2%**, **+/-10%** or **+/-20%** is selected, the terminal tries to capture zero upon power up. If there is motion during a power-up zero capture function, the terminal will continue to check for a no-motion condition until zero is captured. Once a no-motion condition is reached, it will automatically capture zero.

For example, if the setting for Power Up Zero is set at 2%, Power Up Zero will only occur when the weight reading on the scale is within +/- 2% of the original calibrated zero condition.

Selections for unapproved scale selections are:

oFF, 2, **10** [default], 20

Selections for approved scales are:

oFF, 2, **10** [default]

- When the scale's approval is set to **OIML**, if Power Up Zero capture is enabled and the weight on the scale is outside of the zero capture range, a warning message will display (Figure 3-21) until the weight is removed and zero is captured.



Figure 3-21: OIML Zero Capture Warning

3.4.4.4. F1.4.4 Pushbutton Zero

When Pushbutton Zero is set to **Off**, the front panel ZERO pushbutton will not operate to capture a new zero reference point. If a range of **+/-2%** , **+/- 10%** or **+/- 20%** is selected, pushbutton zero will operate within the selected range to rezero the scale.

For example, if Pushbutton Zero is set to **+/-2%**, the Pushbutton Zero can only be used when the weight reading on the scale is within **+/- 2%** of the original calibrated zero condition.



Figure 3-22: Pushbutton Zero Value Selection Screen

- If Pushbutton Zero is **Off**, it is still possible to execute a remote Zero via SICS or CPTZ commands from a PC using a discrete input command.

Selections for scales not legal for trade are:

oFF, 2 [default], 10, 20;

Selections for approved scales are:

oFF, 2 [default]

The zeroing function does not affect the overall scale weighing range, and the scale capacity will not be affected.

If Auto Clear Tare is enabled (refer to page 3-17), a successful Pushbutton Zero operation will also clear the Tare value automatically.

3.4.5. F1.5 Tare

Tare is used to subtract the weight of an empty container from the gross weight on the scale to determine the net weight of the contents. Tare is inhibited if the scale is in motion.

3.4.5.1. F1.5.1 Pushbutton Tare

Selections for Pushbutton Tare are:

on [default], oFF

If the Tare key  is pressed when keyboard tare is disabled, a warning message **--n 0--** will appear.

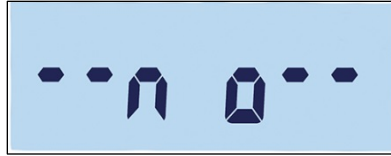



Figure 3-23: Warning Message – Pushbutton Tare Disabled

3.4.5.2. F1.5.2 Tare Interlock

If Tare Interlock is activated (F1.5.2 = on), the tare weight can only be cleared when weighing platform is unloaded to zero, or warning message “-no--” will appear after  is pressed.

on, off [default]

3.4.5.3. F1.5.3 Auto Tare

Selections for Auto Tare are:

on, off [default]



Figure 3-24: Auto Tare Setting Screen

When Auto Tare is active, when an empty container is placed on the platform the measured weight is automatically saved as the tare weight. “Zero” displays and the NET indicator appears.

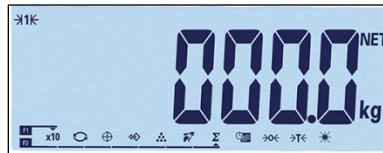

Figure 3-25: Display After Auto Tare

3.4.5.4. F1.5.4 Auto Tare Threshold

When Auto Tare is active, the F1.5.4 menu permits adjustment of the auto tare threshold. When weight on the scale platform exceeds the tare threshold value and settles to no-motion, the terminal automatically tares.

The factory setting is **10**, so that when tare weight is above 10 divisions, an auto tare operation can be executed.

3.4.5.5. F1.5.5 Auto Tare Reset Threshold

When Auto Tare is active, F1.5.5 permits adjustment of the auto tare reset threshold. When the weight on the scale platform falls below the reset threshold value, such as when a load has been removed, the terminal automatically resets the auto tare trigger, depending on how motion checking

(refer to page 3-19) is programmed. The reset threshold weight must be less than the tare threshold weight.

The default value for the Auto Tare Reset Threshold is **10**. So, for example, after the initial auto tare operation is complete and a tare is set, a load of less than 10 divisions can be added without changing the tare value. When the first load is removed and a second load of 10 divisions or greater is added, the terminal will capture a new tare weight automatically.

3.4.5.6. F1.5.6 Auto Clear Tare

Selections for the Auto Clear Tare function are:

on, **OFF** [default]



Figure 3-26: Auto Clear Tare Setting Screen

After the scale is unloaded, the terminal will automatically clear tare.



Figure 3-27: Display After Auto Clear Tare

3.4.6. F1.6 Second Units

This setup screen enables the selection of a second unit.

3.4.6.1. Second Unit

In order to support locations and applications that use multiple measurement units, the IND231/IND236 supports unit switching. Use the Second Unit selection menu to select a second weighing unit or to select none. The weight will be converted from primary to the selected secondary unit when the Unit Switch key  is pressed.

Available selections are:

Kilograms (kg) [default], Grams (g), Pounds (lb), Ounces (oz)

For example, a primary unit of "kg" can be set from the F1.2.1 menu (Figure 3-28), while the F1.6 menu can be used to set the secondary unit as "g" (Figure 3-29). Press the Unit Switch key (by default, F2 – Figure 3-31) to switch between 1.500 kg (Figure 3-30) and 1500 g (Figure 3-32).



Figure 3-28: Primary Units Setting Screen



Figure 3-29: Secondary Units Setting Screen



Figure 3-30: Display Showing Primary Units



Figure 3-31: Unit Switching Via F2 Key



Figure 3-32: Display Showing Secondary Units

3.4.7. F1.7 Filter

3.4.7.1. F1.7.1 Filtering

The IND231/IND236 terminal has a vibration filter that can be set for several conditions. The heavier the filtering, the slower the display settling time will be.

Filter selections are:

Low, **Mid** [default], High

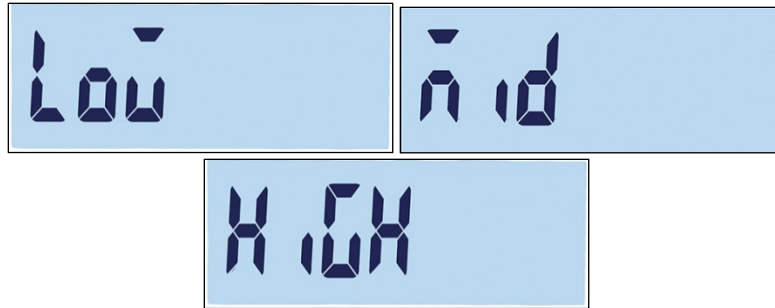

Figure 3-33: Filtering Menu Screen and Setting Screens

3.4.7.2. F1.7.2 Motion Range

The Motion Range value is defined based on division size. When the weight range is within the configured motion range, the terminal treats the scale as stable.

The Motion Range selections are:

0.5d [default], 1d, 3d.



Figure 3-34: Motion Range Setting Screen

3.4.8. F1.10 Scale Block Reset

To initiate a reset of the Scale branch, access the F1.10 menu.

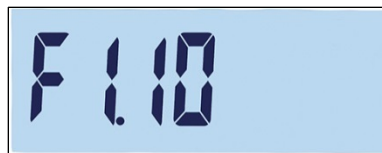





Figure 3-35: Scale Block Reset Menu Screen

A message will prompt "Sure?"



Figure 3-36: Scale Block Reset Confirmation Prompt

Press either  or  to reset the scale block. Press  or  to abort the resetting process.

- Scale reset does NOT include the reset of metrological significant parameters – scale type, approval, weight units, capacity, increment, or calibration data. This data is reset only by performing a Master Reset (refer to page 3-42).

3.5. F2 Application

Figure 3-37 shows a detailed view of the parameters available in the Maintenance branch of the setup menu. Each of these setup parameters is described in this section.

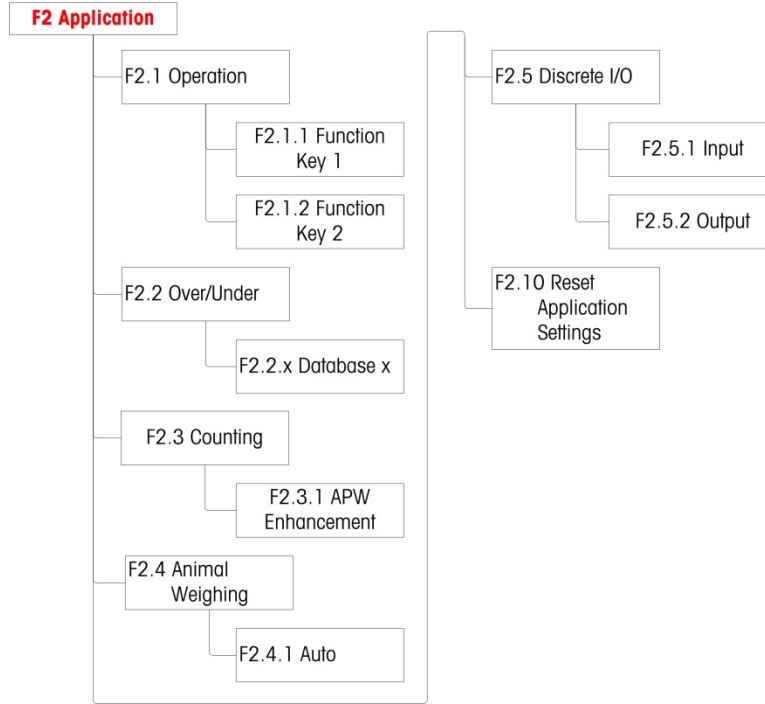

Figure 3-37: Application Menu Structure

3.5.1. F2.1 Operation

3.5.1.1. F2.1.1, F2.1.2 Function Key Setup

Each of the two function keys on the terminal's front panel, **F1** and **F2**, can be assigned to perform a specific operation such as switching units or activating one of the applications. Available assignments are shown in Figure 3-38 and Table 3-3.

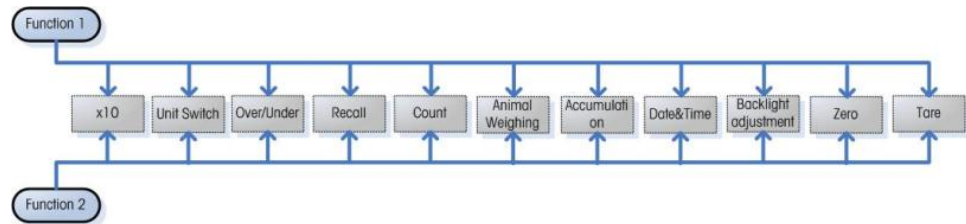

Figure 3-38: Function Key Assignments

- Only one application can be selected for activation by a function key. If an application is assigned to each key (for example, F1 = Counting, F2 = Animal Weighing), only the first application activated will work. If F1 is pressed, the terminal will enter Counting mode; pressing F2 will not activate Animal Weighing. Instead, a warning prompt will display (Figure 3-39). Exit the active application before pressing F2 to activate another application.

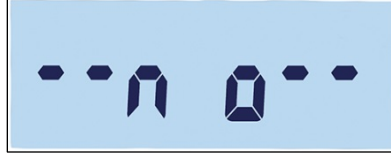

Figure 3-39: Second Application Warning Message

- Function keys can also be configured from the home screen. Press and hold the function key to be configured to access the configuration screen (Figure 3-40, Figure 3-41).

3.5.1.2. Assignment

Options for the assignment of the function keys are listed in Table 3-3.

Table 3-3: Functions

Symbol	Function	Symbol	Function
x10	Expand weight display resolution by one digit	Σ	Accumulation
	Unit switching		Date & Time
	Check weighing		Backlight adjust
	Recall stored target	$\rightarrow 0 \leftarrow$	Zero
	Counting	$\rightarrow T \leftarrow$	Tare
	Animal weighing		

For details on the setup, configuration and operation of each of the applications, please refer to Chapter 2, **Operation**.

3.5.1.3. F2.1.1 Function Key 1

Access the F2.1.1 menu. Use the up $\rightarrow 0 \leftarrow$ and down $\rightarrow T \leftarrow$ keys to select the required function from the options shown in Table 3-3. Focus will change to indicate the selected function, as shown in Figure 3-40, where **Expand x10** is selected. Press $\rightarrow 0 \leftarrow$ to confirm the selection.

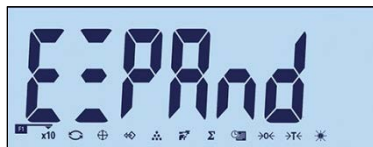

Figure 3-40: Configuring Function Key 1

3.5.1.4. F2.1.2 Function key 2

Access the F2.1.1 menu and use the up $\rightarrow 0 \leftarrow$ and down $\rightarrow T \leftarrow$ keys to select the required function. Focus will change to indicate the selected function, as shown in Figure 3-41, where **Animal Weighing** is selected. Press $\rightarrow 0 \leftarrow$ to confirm the selection.



Figure 3-41: Configuring Function Key 2

3.5.2. F2.2 Over/Under Database

Up to ten targets and tolerance values can be stored for Over/Under checkweighing. The menu structure displays existing records (Figure 3-43) in numerical order, and then displays the screens used to create a new set of values (Figure 3-44, etc.).

Figure 3-42 provides a graphical summary of record management procedures in the IND231/IND236 terminal.

Create record

- Index: record number
- Target
- Tol-
- Tol+
- Tare



Figure 3-43: Screen Displaying Record Index Number

Once all existing records have been displayed, the Create screen (Figure 3-44) appears, and after it a series of parameter setting screens.



Figure 3-44: Create Record Screen

3.5.2.2. Creating a Record

To create a new record number x (where x is a value from 1 to 10):

1. With the Create screen (Figure 3-44) showing, press .
2. rEC no. appears briefly, and then the record number editing screen (Figure 3-45). The terminal can save up to 10 records. By default, the system offers the next available number.

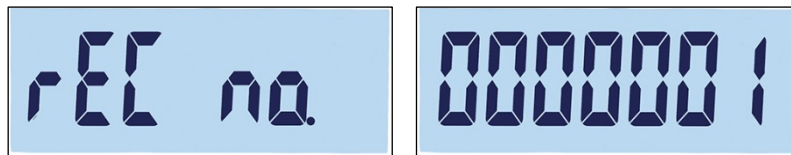



Figure 3-45: Record Number Label and Record Number Setting Screens

3. Either accept the proposed number by pressing , or use the direction keys to adjust the number. If an existing number is selected, an Overwrite confirmation message (Figure 3-46) displays.

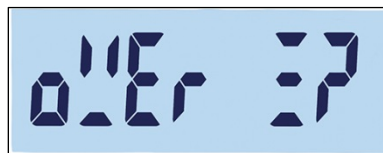



Figure 3-46: Overwrite Record Confirmation Screen

Press  to confirm the action, or  to return to the Create screen.

- Once the record number is confirmed by pressing , the **target** screen will appear briefly, and then the target editing screen (Figure 3-47).

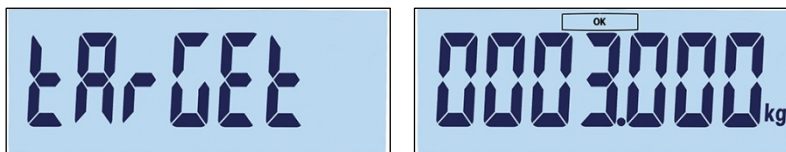



Figure 3-47: Target Label and Setting Screens

Use the direction keys to select and adjust the numbers (refer to **Setting Numbers** on page 3-4). Once the correct value is displayed, press  to move to the next step.

- Next, the negative tolerance (Tol -) screen appears, followed by the negative tolerance editing screen (Figure 3-48).

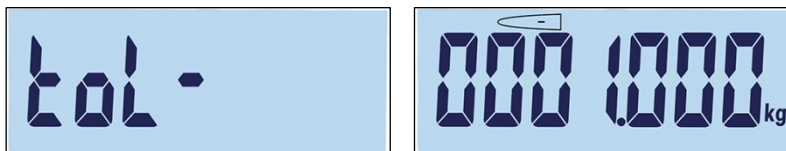



Figure 3-48: Negative Tolerance Label and Setting Screens

Use the direction keys to adjust the number. Once the correct value is displayed, press  to move to the next step.

- The target value can also be set by adding weight to the scale.

- The positive tolerance (Tol +) is edited in the next screen (Figure 3-49). Once the value is set, press  to move to the next step.

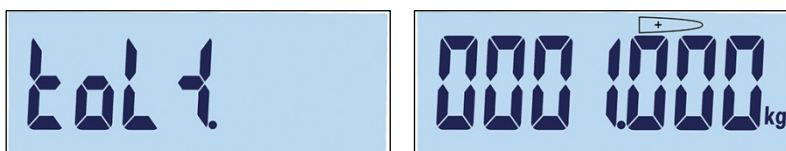



Figure 3-49: Positive Tolerance Label and Setting Screens

- Finally, a **tare** value can be set for the record (Figure 3-50). Press  to confirm the record and exit the record editing function.

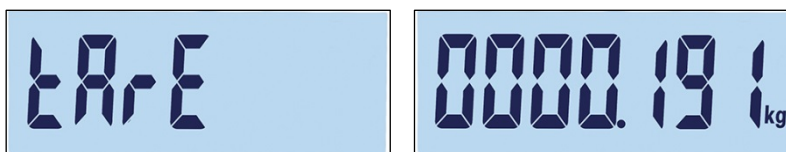





Figure 3-50: Positive Tolerance Label and Setting Screens

Once the record is saved in the database, "Record x" (the newly created record) will appear as the active item in the F 2.2 submenu. Press  to view its configuration details.

3.5.2.3. Replacing Existing Records

To **overwrite** a record, access the "Create" screen and edit the Record Number screen to show the number of the existing record to be overwritten. Press . An overwrite confirmation message (Figure 3-46) will appear. Press  to confirm the action, or  to return to the Create screen.

3.5.2.4. Deleting Existing Records





To **delete** a record, access F2.2 and use UP  or DOWN  keys to display the Record Number of the record to be deleted. With the record's label displayed, press . A confirmation message (Figure 3-51) will appear.



Figure 3-51: Delete Record Confirmation Screen

Press either  to preserve the record and return to the Record Number display screen, or  to confirm its deletion. If a higher numbered record exists, the next record number is displayed. If the deleted record was the highest numbered record, or no other records exist, the Create screen is displayed.

3.5.3. F2.3 Counting

3.5.3.1. F2.3.1 APW Enhancement

The IND231/IND236 terminal can be configured to enhance the Average Piece Weight value continuously during operation. Settings are:

on, oFF [default]

When APW enhancement is set to **On**, the weighing terminal automatically determines the piece weight again when the number of reference parts is increased.

3.5.4. F2.4 Animal Weighing

3.5.4.1. F2.4.1 Auto Start

The Animal Weighing application can be configured to start automatically when weight is placed on the platform. Settings are:

on [default], oFF

When Auto Start is active, if the weight on the platform is larger than 9d the animal weighing function will run automatically. The final average weight will be shown on the display with star "*" symbol.

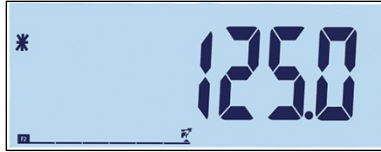

Figure 3-52: Animal Weighing Display, Final Average Weight

When the weight is removed from the platform, the weight will return to zero and the star “*” symbol will disappear.

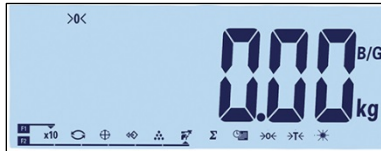

Figure 3-53: Animal Weighing, Scale Weight Returned to Zero

3.5.5. F2.5 Discrete I/O

Functions can be assigned to the discrete inputs, and statuses to the discrete outputs. When one of statuses is on (true), the output is set to active.

3.5.5.1. F2.5.1 Input

The discrete input can be used to monitor the function key actions, as indicated in Table 3-4. Default settings are shown in **bold**.

Table 3-4: Discrete I/O Input Assignments

Menu address	Function	Assignments
F2.5.1.1	Input 1	Off , Zero, Tare, Print, Unit switch, Clear, Blank
F2.5.1.2	Input 2	Off , Zero, Tare, Print, Unit switch, Clear, Blank

3.5.5.2. F2.5.2 Output

Table 3-5 lists discrete output assignments. The statuses of each assignment are shown in Table 3-6. Default values are shown in **bold**.

Table 3-5: Discrete I/O Output Assignments

Menu address	Function	Assignments
F2.5.2.x [x = 1 - 4]	Output x [x = 1 - 4]	Off , Over Tolerance, Under Tolerance, T OK, Net, Motion, Over Load, Under Load, Center of Zero

Table 3-6: Discrete I/O Output Statuses

Status	Explanation
Off	No status assigned, always inactive
Over Tolerance	Active when weight is above TOL+

Status	Explanation
Under Tolerance	Active when weight is less than TOL- and larger than 5% of TOL-
Tolerance OK	Active when weight is within tolerance
Net	Active when in net weighing mode
Motion	Active when motion symbol appears
Over Load	Active when weight is overload
Under Load	Active when weight is underload
Center of Zero	Active when  is shown

3.5.6. F2.10 Application Block Reset

To initiate a reset of the Application branch, access the F2.10 menu.







Figure 3-54: Application Block Reset Menu Screen

A message will prompt "Sure?"



Figure 3-55: Application Block Reset Confirmation Prompt

Press either  or  to reset the scale block. Press  or  to abort the resetting process.

3.6. F3 Terminal

Figure 3-56 shows a detailed view of the parameters available in the Terminal branch of the setup menu. Each of these setup parameters is described in this section.

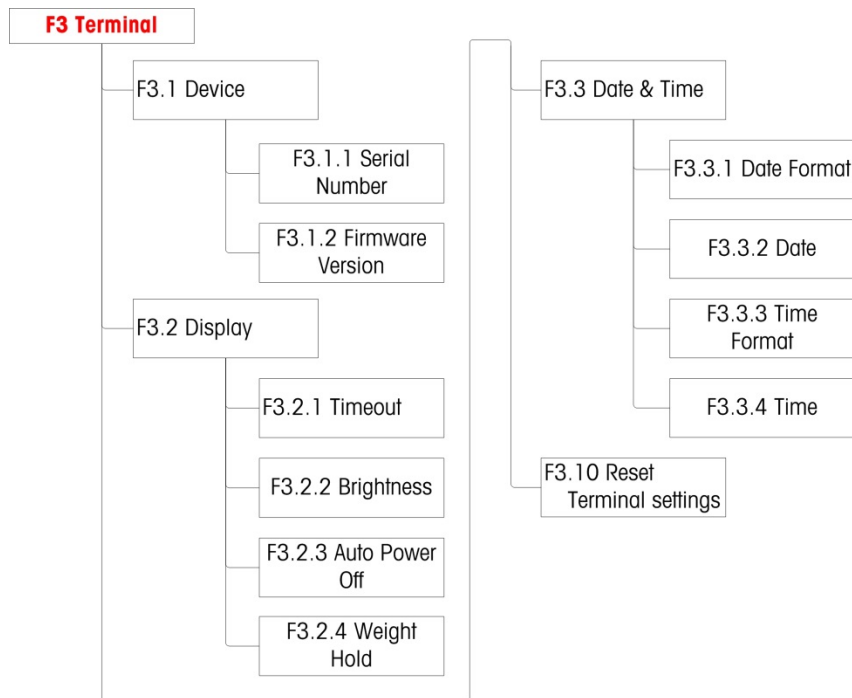

Figure 3-56: Terminal Menu Structure

3.6.1. F3.1 Serial Number

3.6.1.1. F3.1.1 Serial Number

This screen displays the terminal's ten-digit serial number. This number can be viewed, but not edited.

3.6.1.2. F3.1.2 Firmware Version

This screen displays the currently installed version number of the currently installed firmware.

3.6.2. F3.2 Display

Use the Display setup screen to set the screen saver and backlight timeouts and the brightness of the display.

3.6.2.1. F3.2.1 Screensaver and Backlight Timeout

This parameter selects the length of time that the backlight will stay on when the scale is at center of zero, no scale motion is detected, and there is no keypad activity. After the set amount of time elapses, the screensaver replaces the view on the display screen and the backlight is turned off. If motion is detected or any key is pressed, the screen saver closes and the backlight turns on.

■ A keystroke used to exit the screen saver mode is ignored for all other purposes.



Timeout selections are:

0, 5, 10, 15, 30, **60** [default], 120, 300, 600 seconds

When **0** is select, the display will not time out and the backlight will stay On until power is removed from the terminal. When any other value is selected, the backlight will go off after the specified interval, and the time of day will be displayed.

3.6.2.2.

F3.2.2 Brightness

This parameter accesses a screen where the display brightness can be adjusted. Use  up or  down keys to select the appropriate setting for the terminal's environment.

Possible selections are:

- Off** Turn off backlight
- Low:** Low brightness (battery power saving mode)
- High:** High brightness

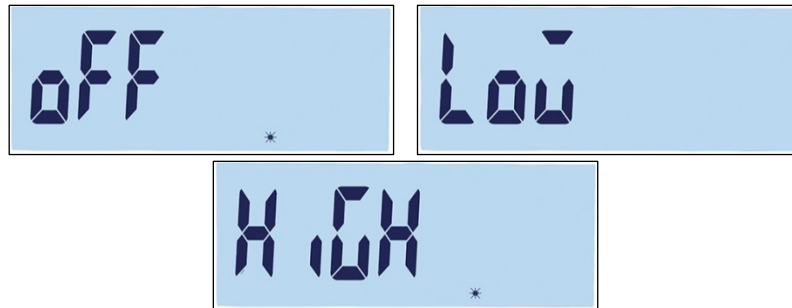





Figure 3-57: Backlight Settings

Press  to exit the adjustment screen and return to the F3.2.2 menu. Press  or  to confirm the selected brightness setting and return to the F3.2.3 menu.

3.6.2.3.

F3.2.3 Auto Power Off

This parameter helps conserve battery power by selecting the length of time that the terminal will stay on when the scale is at center of zero, no scale motion is detected, and there is no keypad activity.

Selections are:

0 [default, AC version], **1**, **5** [default, battery version], 15, 30, 60 minutes

If 0 minutes is selected, the terminal will never turn itself off.

3.6.2.4.

F3.2.4 – Weight Hold

This parameter determines the length of time that the weight is displayed on screen with a star symbol after a print operation.

Selections are:

0 [default], 1, 2...9 seconds

3.6.3. F3.3 Date & Time

Select the hour, minutes, day, month, and year on this setup screen. The terminal automatically adjusts the date for a leap year, and a battery backup maintains the time and date settings in the event of a power outage.

■ For daylight savings time adjustments, the time must be changed manually.

3.6.3.1. F3.3.1 Date format

Selections for the date format are:

MM/DD/YYYY, DD/MM/YYYY, YYYY/MM/DD [default]

3.6.3.2. F3.3.2 Set Date

3.6.3.2.1. Day, Month and Year

When F3.3.2 is first accessed, the screen shown in Figure 3-58 is displayed briefly, then the date currently set. Use the direction keys to adjust Day, Month and Year. In the example shown, the date format is YY-MM-DD.

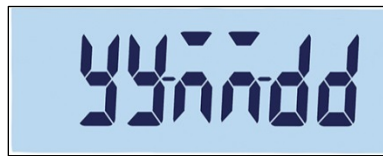



Figure 3-58: Date Adjustment Screen

■ Press  to save changes and leave the adjustment screen, or  to leave the screen without saving any changes.

3.6.3.3. F3.3.3 Time format

Selections for the time format are:

12, 24 [default]

3.6.3.4. F3.3.4 Set Time

3.6.3.4.1. Hour and Minutes

Use direction keys to adjust Hour and minutes in Figure 3-51. The time format is : 24:MM:SS

When the screen shown in Figure 3-59 is displayed, use the direction keys to adjust Hours and Minutes. In the example shown, the time format is HH:MM:SS.

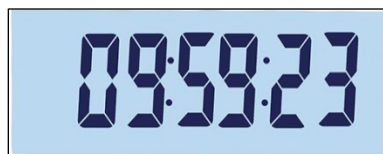



Figure 3-59: Time Adjustment Screen

- Press  to save changes and leave the adjustment screen, or  to leave the screen without saving any changes.

3.6.4. F3.10 Terminal Block Reset

To initiate a reset of the Terminal branch, access the F3.10 menu.







Figure 3-60: Terminal Block Reset Menu Screen

A message will prompt "Sure?"



Figure 3-61: Terminal Block Reset Confirmation Prompt

Press either  or  to reset the scale block. Press  or  to abort the resetting process.

3.7. F4 Communication

Figure 3-62 shows a detailed view of the parameters available in the Communication branch of the setup menu. Each of these setup parameters is described in this section.

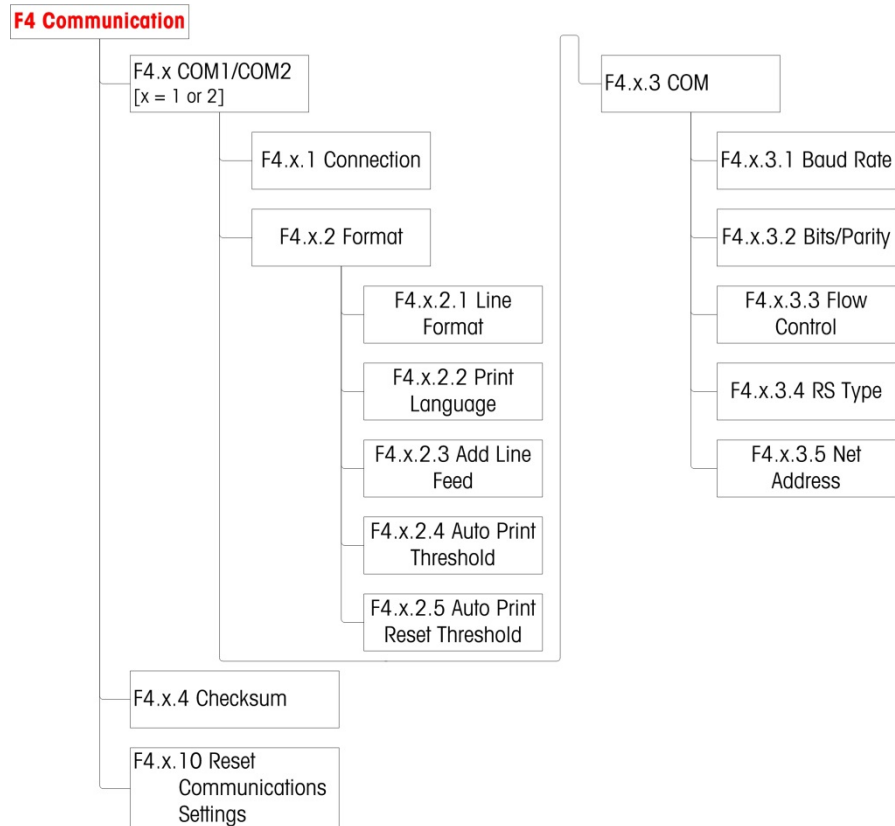

Figure 3-62: Communication Menu Structure

3.7.1. F4.1 COM1

3.7.1.1. F4.1.1 Connection Mode

The connection mode setup screens are used to assign a function to a physical port in the terminal. The optional ports are only available if the appropriate option board has been installed.

Setup pages are available for the IND231/IND236 terminal's COM1, COM2, USB and Discrete I/O ports. Table 3-7 shows the available connection modes, which determine the type of communication that will occur over the port. If no mode is assigned to a port, no data communication will occur using that port. Specific details of these modes can be found in Appendix C, **Communications**.

Table 3-7: Connection Modes

Mode	Description	
Print [default]		
Auto Print	Stable weight values are printed automatically	
SICS	Communication via the METTLER TOLEDO Standard Interface Command Set	
Toledo Continuous		

3.7.1.2. F4.1.2 Format

Format selections for the COM2 connection are detailed in Table 3-8.

Table 3-8: COM1 Format Assignments

Port	Assignment if connection mode is Print or Auto print			
COM1= RS-232	F4.1.2.1	Line Format	Multi-line, Single-line	Figure 3-63
	F4.1.2.2	Print Language	English, Chinese	Figure 3-64
	F4.1.2.3	Add Line Feed	0,1,2,3,4,5,6,7,8,9	
	Assignment if Connection mode is Auto Print			
	F4.1.2.4	Auto Print Threshold	0 - full capacity	
	F4.1.2.5	Auto Print reset threshold	0 - full capacity	

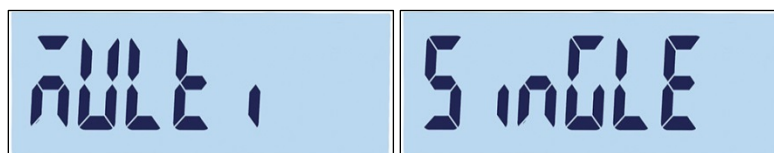

Figure 3-63: Line Format Options

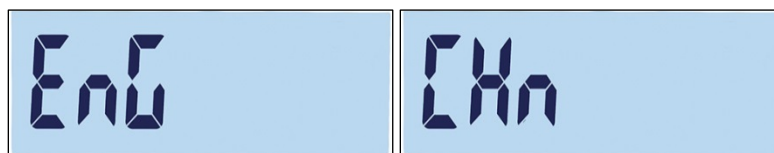

Figure 3-64: Language Options

3.7.1.3. F4.1.3 Port Parameters

3.7.1.3.1. F4.1.3.1 Baud Rate

Baud rate selections for the serial port are:

1200, 2400, 4800, **9600 [default]**, 19200, 38400, 57600, 115200

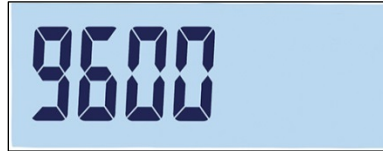

Figure 3-65: Baud Rate Screen

3.7.1.3.2. F4.1.3.2 Data Bits / Parity

Data bits and Parity selections are:

7 – odd 7 bits, parity odd, 7 – even 7 bits, parity even, **8 – none 8 bits, no parity [default]**



Figure 3-66: Data Bits/Parity Screens

3.7.1.3.3. F4.1.3.3 Flow Control

Flow control selections are:

On – Flow control XON-XOFF enabled (software handshaking), **Off – Flow control disabled [default]**

3.7.1.4. F4.1.4 Checksum

The Checksum parameter is only available when F4.1.1 is set to **Toledo Continuous**. Checksum selections are:

On, **Off [default]**

3.7.1.5. F4.1.10 Communication Reset

To initiate a reset of the Terminal branch, access the F3.10 menu.







Figure 3-67: COM1 Communication Reset Menu Screen

A message will prompt "Sure?"



Figure 3-68: COM1 Communication Reset Confirmation Prompt

Press either  or  to reset the scale block. Press  or  to abort the resetting process.

3.7.2. F4.2 – COM 2

The COM2 ports are only shown if the corresponding option board has been installed.

- If COM2 is either the RS232 or USB option, the communication menu is the same as for COM1, described in section F4.1 COM1.
- If COM2 is the RS422/485 option, F4.2.3.5 is used to set the net address.

3.7.2.1. F4.2.1 Connection Mode

Selections for the COM2 connection mode are the same as those shown in Table 3-7:

Print [default], Auto Print, SICS, Toledo Continuous

For information about these settings, please refer F4.1.1 Connection Mode, above

3.7.2.2. F4.2.2 Format

Format selections for the COM2 connection are detailed in Table 3-9 and Table 3-10.

Table 3-9: COM2 RS-232/USB Format Assignments

Port	Assignment if connection mode is Print or Auto print			
COM1= RS-232 or USB	F4.2.2.1	Line Format	Multi-line, Single-line	Figure 3-63
	F4.2.2.2	Print Language	English, Chinese	Figure 3-64
	F4.2.2.3	Add Line Feed	0,1,2,3,4,5,6,7,8,9	
	Assignment if Connection mode is Auto Print			
	F4.2.2.4	Auto Print Threshold	0 - full capacity	
	F4.2.2.5	Auto Print reset threshold	0 - full capacity	

Table 3-10: COM2 RS-422/RS-485 Format Assignments

Port	Assignment if connection mode is Print or Auto print			
COM1= RS-422, RS-485	F4.2.2.1	Line Format	Multi-line, Single-line	Figure 3-63
	F4.2.2.2	Print Language	English, Chinese	Figure 3-64
	F4.2.2.3	Add Line Feed	0,1,2,3,4,5,6,7,8,9	
	Assignment if Connection mode is Auto Print			
	F4.2.2.4	Auto Print Threshold	0 - full capacity	
	F4.2.2.5	Auto Print reset threshold	0 - full capacity	

3.7.2.3. F4.2.3 Port Parameters

For F4.2.3.1, F4.2.3.2 and F4.2.3.3, refer to the settings described under F4.1.3 Port Parameters, above.

■ If COM 2 is RS422/485 option, F4.2.3.5 is used to set the net address.

3.7.2.3.1. F4.2.3.4 RS Type (Only available on COM2)

F4.2.3.4 sets the type of option board used by COM2. Selections are:

RS-232[default], RS422, RS485

3.7.2.3.2. F4.2.3.5 Net Address (only available for RS4xx)

Address selections are:

Off [default], 0, 1, 2, 3, 4, 5, 6, 7, 8, 9

Except when it is in SICS mode, RS-422/485 communication works in the same way as RS-232. When a net address is activated in SICS mode, the terminal can only accept a command that includes the correct net address, as shown in Table 3-11 and the example below.

■ For further information about SICS communication, refer to Appendix C, **Communications**.

Table 3-11: Net Address Commands, SICS Mode

	ESC (Header)	Address	Command
Send:	ESC	9	SI
Receive:	ESC	9	S S 0.00 kg

For example, when net address of RS422/485 is **9**, the command should be:

S: ESC9SI

R: ESC9S S 0.00 kg

3.7.2.4. F4.2.4 Checksum

When F4.2.1, **Connection Mode**, is set to **Toledo Continuous**, a Checksum can be enabled. Settings are:

On – Checksum control enabled, **Off** – Checksum disabled [default]

3.8. F5 Maintenance

Figure 3-69 shows a detailed view of the parameters available in the Maintenance branch of the setup menu. Each of these setup parameters is described in this section.

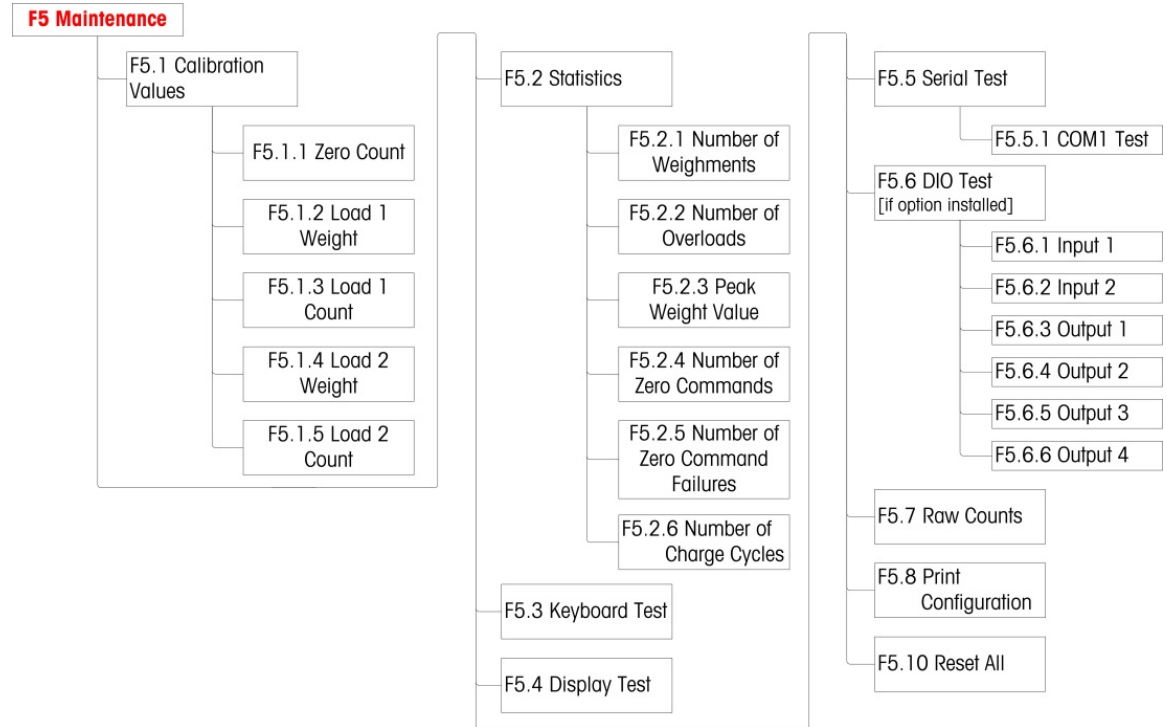



Figure 3-69: Maintenance Menu Structure

3.8.1. F5.1 Calibration values

The Calibration Values screens display the current calibration values for the scale. The number of screens displaying test load calibration values (F5.1.1 to F5.1.5) is determined by the Linearity Adjustment setting configured for the scale – refer to F1.3 Calibration starting on page 3-11.

These calibration values can be printed out (refer to **F5.8 Print Configuration**, on page 3-42) or written down, then manually entered into a new replacement board should a failure ever occur, which eliminates having to recalibrate the scale with test weights. While this method is quick, it is not as accurate as placing test weights on the scale.

Use the direction keys to select a calibration value to be modified. Press the  key to return to the menu.

■ If the terminal is not legal for trade (refer to F1.1.2 Approval on page 3-8), F5.1 is hidden.

3.8.1.1. F5.1.1 Zero Count

Displays the raw count value of the zero point set in most recent calibration.

3.8.1.2. F5.1.2 Load 1 Weight (Half Capacity)

If linearity calibration has been performed, displays the half capacity weight value.

3.8.1.3. F5.1.3 Load 1 Count (Half Capacity)

If linearity calibration has been performed, displays the half capacity raw count value.

3.8.1.4. F5.1.4 Load 2 Weight (Full Capacity)

Displays the full capacity weight value set in the most recent calibration.

3.8.1.5. F5.1.5 Load 2 Count (Full Capacity)

Displays the full capacity raw count value set in the most recent calibration.

3.8.2. F5.2 – Statistics

This weighing instrument features several control functions to monitor the condition of the device. A METTLER TOLEDO service technician can set up and enable these functions. This helps the user and the METTLER TOLEDO service technician to determine how the device is treated and what measures are needed to keep it in good working order.

All statistics refer to the period since the last master reset. Refer to page 3-42.

3.8.2.1. F5.2.1 Number of Weighments

Displays the sequence number of the most recent weighing operation.

3.8.2.2. F5.2.2 Number of Overloads

Displays the number of overloads recorded by the terminal.

3.8.2.3. F5.2.3 Peak Weight Value

Displays the highest recorded weight value from all weighments.

3.8.2.4. F5.2.4 Number of Zero Commands

Displays the number of times a zero command has been issued.

3.8.2.5. F5.2.5 Number of Zero Command Failures

Show the number of failures of zero operation.

3.8.2.6. F5.2.6 Number of Charge Cycles

Shows the number of times the battery has been charged.

3.8.3. F5.3 Keyboard Test

The Keyboard Test screen allows the terminal keys to be tested, including the scale function keys and the print key.



Press any of the keys shown in Table 3-12, and the screen will display the corresponding graphic. When testing is complete, press the  key to return to the menu.

Table 3-12: Keyboard Test Displays

3.8.4. F5.4 Display Test

When F5.4 is accessed, the Display Test screen displays all LCD segments. This screen will continue to display until the  key is pressed to return to the menu.

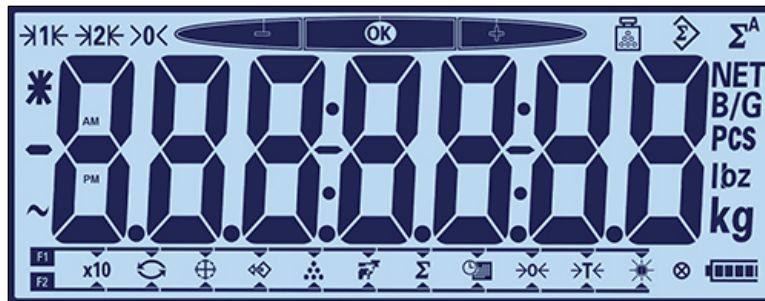

Figure 3-70: Display Test, All LCD Segments Displayed

3.8.5. F5.5 Serial Test

3.8.5.1. F5.5.1 COM1 Test

The COM1 test allows the COM1 connector on the mainboard to be tested. Short circuit (jumper) COM1 TxD Pin and RxD Pin.

The terminal will display a screen like the one shown in Figure 3-71, with transmitted data shown on the left and received data on the right. If the transmitted and received data match, the COM1 circuit is correct. If they are not the same, the circuit is faulty.



Figure 3-71: COM1 Serial Test Screen

Please press  key to end the test.

3.8.6. F5.6 Discrete I/O Test



This function tests the status of inputs and outputs in the discrete I/O connector. The terminal can display the status of input x (where x is either input 1 or input 2). Outputs 1 through 4 can be tested by selecting On or Off from the F5.6. x screen (where x 1, 2, 3 or 4).

F5.6 is visible in the menu structure only if COM2 is the optional discrete I/O board.

3.8.6.1. F5.6.1, F5.6.2 Input 1 Test and Input 2 Test

These screens display the test status of Inputs 1 and 2, respectively. Inputs are shown as on or off.

3.8.6.2. F5.6.3, F5.6.4, F5.6.5, F5.6.6 Output Tests

	 WARNING
	<p>THE DISCRETE OUTPUTS OF THE TERMINAL WILL BE MANUALLY ENABLED DURING THIS TEST. REMOVE OUTPUT CONTROL POWER SO EXTERNAL EQUIPMENT WILL NOT BE ENERGIZED BY MISTAKE. EXERCISE CARE WHEN MAKING CHECKS, TESTS AND ADJUSTMENTS THAT MUST BE MADE WITH POWER ON. FAILURE TO OBSERVE THESE PRECAUTIONS CAN RESULT IN BODILY HARM AND/OR PROPERTY DAMAGE.</p>

These screens display the test status of Outputs 1, 2, 3 and 4 respectively. Outputs are shown as on or off.

3.8.7. F5.7 Raw counts

The F5.7 screen displays the terminal's current raw count value.

3.8.8. F5.8 Print Configuration

When F5.8 is accessed, a list of all visible setup parameters and calibration values is printed. If the terminal is approved, hidden setup blocks will not be printed. While the data is being sent, the message "Print" is displayed.



Figure 3-72: Terminal Configuration Print Message

3.8.9. F5.10 Reset All to Factory Default Settings

Factory default settings can be restored individually for branches such as scale, application, terminal and communication, usually from the last branch of the respective menu structures. With the exception of metrologically significant settings such as Scale Type and Capacity, all parameters can be restored to their factory defaults using the Reset All screen under the Maintenance branch.



To initiate the reset, access the F5.10 screen and press either  or .



Figure 3-73: Reset All Menu Screen

A message will prompt "Sure?"



Press  or  to abort the resetting process and return to the menu tree.



Figure 3-74: Global Reset Confirmation Prompt

4 Service and Maintenance

This chapter covers

- Cleaning and Maintenance
- Service
- Battery Operation
- Troubleshooting
- Connection to InSite™

IND231/IND236 terminal is designed to provide years of dependable operation. However, METTLER TOLEDO recommends that – as with any industrial measurement equipment – the terminal and the connected scale system be serviced periodically. Timely, factory-specified maintenance and calibration by a METTLER TOLEDO authorized service technician will ensure and document accurate and dependable performance to specifications.

4.1. Cleaning and Maintenance



Clean the terminal's keypad and cover with a clean, soft cloth that has been dampened with a mild glass cleaner. Do not use any type of industrial solvent such as toluene or isopropanol (IPA) that could damage the terminal's finish. Do not spray cleaner directly on the terminal.

Regular maintenance inspections and calibration by a qualified service technician are recommended. The IND231/IND236 terminal is a rugged instrument; however, the front panel is a relatively thin covering over sensitive electronic switches and a lighted display. Care should be taken to avoid any punctures to this surface or any vibrations or shocks to the instrument. If the front panel is punctured, ensure that steps are taken to prevent dust and moisture from entering the unit until the terminal can be repaired.

4.2. Service

Only qualified personnel should perform installation, programming, and service. Please contact a local authorized METTLER TOLEDO representative for assistance.

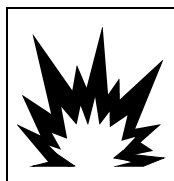
METTLER TOLEDO recommends periodic preventative maintenance to the terminal and scale system to ensure reliability and to maximize service life. All measurement systems should be periodically calibrated and certified as required to meet production, industry and regulatory requirements. We can help you maintain uptime, compliance and quality system documentation with periodic maintenance and calibration services. Contact your local METTLER TOLEDO authorized service organization to discuss your requirements.

	<p style="text-align: center;"> WARNING</p> <p>ONLY PERMIT QUALIFIED PERSONNEL TO SERVICE THE TERMINAL. EXERCISE CARE WHEN MAKING CHECKS, TESTS AND ADJUSTMENTS THAT MUST BE MADE WITH POWER ON. FAILING TO OBSERVE THESE PRECAUTIONS CAN RESULT IN BODILY HARM AND/OR PROPERTY DAMAGE.</p>
---	--

4.3. Battery Operation

As Table 4-1 shows, two kinds of battery configuration can be chosen to supply power to the terminal.

Table 4-1: Battery Options

Battery	IND231	IND236
6 "AA" size batteries	YES	NO
NiMH rechargeable battery	YES	YES

4.3.1. Battery Use

The amount of time the IND231/IND236 will operate on a fully charged battery depends on the number of load cells connected and the use of the backlight. Powering multiple load cells and using the backlight continuously will greatly reduce battery operating time. The AA sized batteries and the NiMH battery pack have similar operating times.

Table 4-2 lists the average expected operating time provided by a new IND231/IND236 battery, based on backlight usage and the number of load cells. As a battery pack ages, its power storage capability diminishes, and operating time will be reduced.

Table 4-2: Expected Battery Life

Continuous Operation Load	Backlight on	Backlight off
Single 350Ω cell, no options	80 hrs	120 hrs
Four 350Ω cells, no options	39 hrs	46 hrs
Single 350Ω cell, COM2 option	47 hrs	58 hrs
Four 350Ω cells, COM2 option	29 hrs	33 hrs

4.3.2. Battery Disposal

Alkaline batteries cannot be recharged, so when the batteries reach the point where they can no longer power the IND231 terminal, all six batteries must be replaced.

As a result of normal use over a period of time, the available power in the 30044650 NiMH battery pack will be reduced and it will lose its ability to power the IND231/IND236 terminal for an extended time. When this occurs, the battery pack should be replaced and the original battery pack must be disposed of properly.

	 CAUTION
	DISPOSE OF USED BATTERY PROMPTLY. KEEP AWAY FROM CHILDREN. DO NOT DISASSEMBLE AND DO NOT DISPOSE OF IN FIRE.

Follow local laws and regulations regarding the disposal of the NiMH battery pack.



4.3.3. Battery Status Icon

The IND231/IND236 terminal provides a battery status icon in the lower right corner of the display to indicate the amount of power remaining in the battery. Table 4-3 shows the full power and lower power icons.

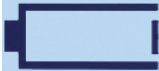
Table 4-3: Battery Status Icon

Graphic	Battery Condition
	Full power
	Less than 10% charge remaining

When the remaining battery power reaches the “extremely low” threshold, the battery graphic on the display will blink, indicating that the battery is getting low. It will continue to blink until the batteries are replaced (alkaline battery version) or the terminal is connected to AC power (NiMH version). If the battery condition is not addressed and the voltage continues to drop, the terminal will turn itself off.

	 CAUTION
	THE BATTERY USED IN THIS DEVICE MAY PRESENT A RISK OF FIRE OR CHEMICAL BURN IF MISTREATED. DO NOT CRUSH, DISASSEMBLE, HEAT ABOVE 60°C OR INCINERATE. REPLACE BATTERY WITH 30044650 ONLY. USE OF ANOTHER BATTERY MAY PRESENT A RISK OF BURN, FIRE OR EXPLOSION.

4.3.4. Alkaline Battery Version

To access the alkaline batteries, it is necessary to remove the plastic battery cover from the back of the IND231 terminal. Press down on the end marked PUSH and slide the cover in the direction of the arrows.



Figure 4-1: Removing the Battery Cover

In the IND231, six AA size battery cells are used. The cells are mounted in a plastic holder, shown installed in Figure 4-2. Note the orientation of the positive poles.

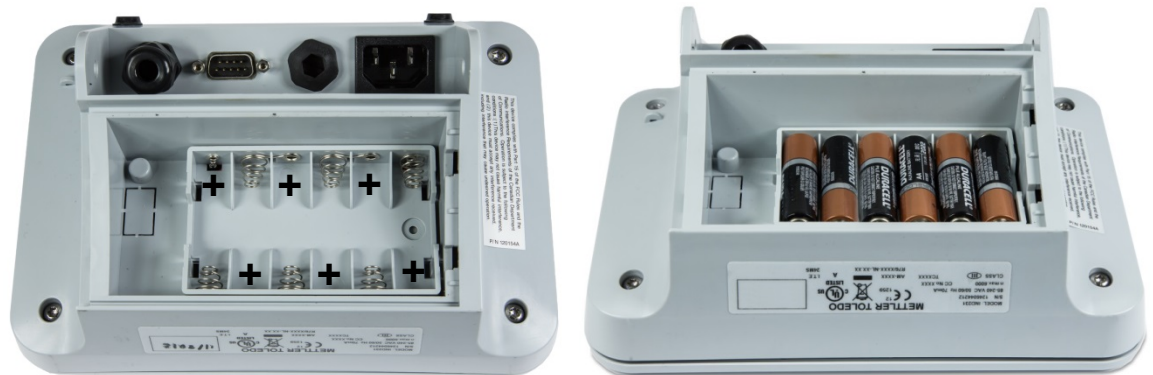

Figure 4-2: IND231 AA Cell Holder Empty (left) and With Cells (right)

The alkaline batteries can be replaced without affecting the terminal's regulatory approvals. Replace the dry cells with exactly the same size. High quality alkaline batteries are recommended.

To reinstall the cover, fit it over the slotted tracks visible in Figure 4-2 and slide it until the clips engage.

4.3.5. Rechargeable NiMH Battery Pack Version

Both the IND231 and the IND236 can be configured to use the rechargeable NiMH battery pack. The battery pack is internally mounted and is not designed to be replaced.

For best battery performance, operate the IND231/IND236 with internal battery at an ambient temperature in the range of 10°C to 30°C (50°F to 86°F). This applies to charging as well as discharging the battery.

4.3.5.1. Battery Charging

The 7.2 volt NiMH battery pack is designed to be charged while inside IND231/IND236 by connecting the AC line cord to an external power source.

Once an NiMH powered terminal is connected to AC power, the charging process begins. The battery graphic changes as shown in Table 4-3 to indicate the status of the charge. The approximate time to recharge a fully discharged battery is 5 hours. The terminal can be used for normal weighing operation under AC power while simultaneously recharging the battery.

When the battery is completely charged, the full power graphic will be displayed until the terminal is turned off and the power plug is pulled out.

4.4. Troubleshooting



Troubleshooting activities described here are to assist in identifying whether the problem is in the IND231/IND236 terminal or has an external cause.

- Battery Power
- Problem Diagnosis
- Error Codes and Error Messages
- Internal Diagnostics

4.4.1. Battery Power

In battery powered IND231/IND236 terminals, if the battery voltage is below a minimum limit, the terminal will not turn on when the On/Off key is pressed.

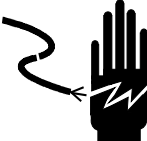
Use a multi-meter to check the battery voltage. The battery voltage can be tested at the end of the internal battery housing where the harness from the main board connects to the battery housing. Make sure the two meter leads do not get shorted together during this test as a large amount of current could be present.

	 CAUTION
	USE CAUTION WHEN TESTING THE BATTERY. A LARGE AMOUNT OF CURRENT MAY BE PRESENT IN THE BATTERY.

The minimum voltage required to operate the IND231/IND236 terminal is 6.8 volts DC. If the battery voltage is below this limit, the battery should be recharged. The value for a fully charged battery is approximately 8.3 volts DC.

4.4.2. Problem Diagnosis

The following chart lists a few potential symptoms and some suggestions for resolving the issue. Use qualified electricians to test for problems with the AC power source. If a problem that is not listed in Table 4-4 occurs, or if the suggested fix does not resolve the problem, contact an authorized METTLER TOLEDO service representative for assistance.

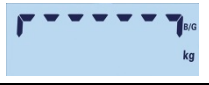



Table 4-4: Symptoms and Corrective Actions

Symptom	Suggestion
Display is blank	<ol style="list-style-type: none"> 1. Confirm source of AC power is OK or confirm battery is fully charged (NiMH) or replace the batteries (alkaline). 2. Contact service representative.
Display is dim	<ol style="list-style-type: none"> 1. Confirm backlight is set correctly. 2. Check to see if backlight harness is loose
Display on but weight does not change	Contact service representative.
No serial port communications	<ol style="list-style-type: none"> 1. In setup, access F5.5, the serial diagnostics section of Maintenance, to determine if the problem is internal or external to the terminal. 2. Contact service representative.
Discrete inputs or outputs don't operate	<ol style="list-style-type: none"> 1. In setup, access F5.6, the discrete input and output diagnostics section of Maintenance, or the DIO status display on the system line, to determine if the problem is internal or external to the terminal. 2. Contact service representative.

4.4.3. Error Codes and Error Messages

The IND231/IND236 terminal uses a combination of error codes and error messages to indicate error conditions that occur in the terminal. Table 4-5 provides a list of error codes that may appear.

Table 4-5: Error Codes

Message	Possible reasons	Solution
	Over load, more than 9d above scale capacity	Reduce the load
	Under Zero by more than 5d	Zero the scale
	Outside the zero range	Remove the load
		Confirm that all initial weight is on the scale platform

Message	Possible reasons	Solution
	Incorrect entry or invalid key press	Wait for message to disappear, make correct entry
	EEPROM verify error	<ol style="list-style-type: none"> 1. Power cycle the terminal 2. Contact service representative
	Scale calibration failure	<ol style="list-style-type: none"> 1. Recalibrate the scale 2. Contact service representative
	Sample number too small	Increase sample quantity
	EEPROM W/R error	Contact service representative
	When F1.4.2 = 20dZero, the display will show this error after the weight drops more than 20d below gross zero.	Clear platform and press the zero key
	Setup access denied	Press the metrology switch to regain access to the setup menu.
	Scale not calibrated	Calibrate the scale
	When the terminal is used as a remote display: Communication error in the port configured for remote display	<ol style="list-style-type: none"> 1. Check the settings of the port (rCOM n) set as remote display interface 2. Confirm main terminal is programmed for data output 3. Check cabling
	The data is longer than the screen can display	Reduce the load on the scale
Terminal turns itself off	Terminal is set auto power off Battery voltage too low	Press On/off key Recharge battery

Error messages appear in the middle part of the display. The message is displayed briefly, then the display returns to its state before the error was detected. Figure 4-3 shows an example of an error message display – in this case, an incorrect value entry or invalid button press.

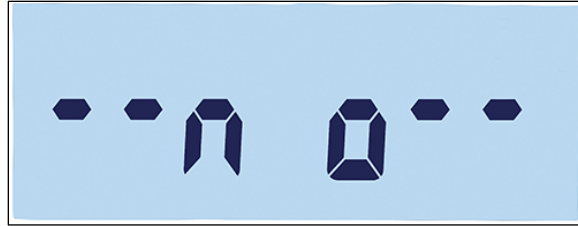

Figure 4-3: Example Error Message Display

4.4.4. Scale Statistics

This weighing instrument features several control functions to monitor the condition of the device. The METTLER TOLEDO service technician can set up and enable these functions. This helps the user and the METTLER TOLEDO service technician to determine how the device is treated and what measures are needed to keep it in good working order.

4.4.4.1. F5.2.1 Number of Weighments

Displays the number of weighments made on the terminal.

4.4.4.2. F5.2.2 Number of Overloads

Displays the number of overloads recorded by the terminal.

4.4.4.3. F5.2.3 Peak Weigh Value

Displays the highest recorded weight value from all weighments.

4.4.4.4. F5.2.4 Number of Zero Commands

Displays the number of times a zero command has been issued.

4.4.4.5. F5.2.5 Number of Zero Command Failures

Show the number of zero commands that have failed.

4.4.4.6. F5.2.6 Number of Charge Cycles

Shows the number of times the NiMH battery pack has been charged.

4.5. Connection to InSite™

When connecting the IND231/236 to InSite SL (for saving and loading settings), the COM1 port must be used. InSite will be able to connect to the COM1 port regardless of its assignment (Print, Autoprint, SICS or Continuous) so the port configuration does not need to be changed. Make sure the IND231/IND236 and InSite baud rate and data bits settings match **before** making the connection. These settings should be:

Baud rate: 9600 Data bits/parity: 8-none

Refer to the [InSite SL User's Guide](#) for details on the tool's functions and capabilities.

A Parameter Values

The following table lists each of the setup parameters shown in the Setup mode. A descriptive name is included, followed by a list of the selections with corresponding selection values.

Default values are indicated by an asterisk [*].

	F-Code	Descriptive Name	Selections and Values
F1-Scale	F1.1.	Scale Type	
	F1.1.1	Type	*SCL RCOM1 RCOM2
	F1.1.2	Approval	*None OIML NTEP AR SRI
	F1.1.3	Remote Protocol	*Toledo Continuous SICS
	F1.2	Capacity and Increment	
	F1.2.1	Unit	g *kg oz lb
	F1.2.2	Range	*1r: One range 2r: Tow ranges
	F1.2.3	Range 1 Capacity	*50, Range :1~500'000
	F1.2.4	Increment Size 1	*0.01, Selections are based on resolution range: 1000~30'000
	F1.2.5	Range 2 Capacity [only available with F1.2.2= 2r]	*50, Range :1~500'000
	F1.2.6	Increment Size 2 [only available with F1.2.2= 2r]	0.0001 0.0002 0.0005 0.001 0.002 0.005 *0.01

	F-Code	Descriptive Name	Selections and Values
F1 - Scale			0.02 0.05 0.1 0.2 0.5 1 2 5 10 20 50 100 200
	F1.3	Calibration	
	F1.3.1	GEO	*16 [01 – 31]
	F1.3.2	Calibration	
	F1.3.3	Linearity Calibration	
	F1.4	Zero	
	F1.4.1	Auto Zero maintenance	Off *0.5d 1d 3d 10d
	F1.4.2	Zero Blanking	*Off 20d 20dZero
	F1.4.3	Power up Zero [Unit : %]	Off 2 *10 20
	F1.4.4	Pushbutton Zero [Unit : %]	Off *2 10 20
	F1.5	Tare	
	F1.5.1	Pushbutton Tare	Off *On
	F1.5.2	Tare Interlock	*Off On
	F1.5.3	Auto Tare	*Off On
	F1.5.4	Auto Tare Threshold	Range 0~FS [Full scale] *10

	F-Code	Descriptive Name	Selections and Values
F1 - Scale		[only available with F1.5.3=On]	
	F1.5.5	Auto Tare Reset Threshold [only available with F1.5.3=On]	Range *0~FS [Full scale]
	F1.5.6	Auto Clear Tare	*Off On
	F1.6	Second Unit	*g kg oz lb
	F1.7	Filter and Stability	
	F1.7.1	Filtering	Low *Middle High
	F1.7.2	Motion Range	Off *0.5d 1d 3d
	F1.10	Scale Block Reset	
F2 - Application	F2.1	Operation	
	F2.1.1	Function Key 1	* Expand display Unit switch Check Weigh Recall Count Animal Weigh Accumulation Date & Time Backlight adjustment Zero Tare
	F2.1.2	Function Key 2	Expand display *Unit switch Check Weigh Recall Count Animal Weigh Accumulation Date & Time Backlight adjustment Zero Tare

	F-Code	Descriptive Name	Selections and Values
F2 - Applications	F2.2	Over/Under Database [Maximum record number =10]	Record 1 Record 2 Record n Create Record: - record number - Target - Tol- - Tol+ - Tare
	F2.3	Count Weigh	
	F2.3.1	APW Enhancement	*Off On
	F2.4	Animal Weigh	
	F2.4.1	Auto Start	*Off On
	F2.5	Discrete I/O	
	F2.5.1	Input	
	F2.5.1.1	Input 1	*Off Zero Tare Print
	F2.5.1.2	Input 2	Unit switch Clear Blank display
	F2.5.2	Output	
	F2.5.2.1	Output 1	*Off Over Tolerance Under Tolerance
	F2.5.2.2	Output 2	Good Range Net
	F2.5.2.3	Output 3	Motion Over Load Under Load
	F2.5.2.4	Output 4	Center of Zero
	F2.10	Application Block Reset	
F3 - Applications	F3.1	Device	
	F3.1.1	Serial Number	[10 digits max.]
	F3.1.2	Firmware Version	xx.xx.xx
	F3.2	Display	

	F-Code	Descriptive Name	Selections and Values
F3 – Terminal	F3.2.1	Timeout [Unit : sec]	0 5 10 15 30 *60 120 300 600
	F3.2.2	Brightness	Off *Low High
	F3.2.3	Auto Power Off [Unit : min]	*0 (AC version) 1 *5 (battery version) 15 30 60
	F3.2.4	Weight Hold	*0 [0-9]
	F3.3	Date & Time	
	F3.3.1	Date Format	MMDDYY DDMMYY *YYMMDD
	F3.3.2	Date	xx-xx-xx
	F3.3.3	Time Format	12h *24h
	F3.3.4	Time	xx:xx:xx
	F3.10	Terminal Block Reset	
	F4- Communication	F4.1	COM1
F4.1.1		Mode [Only available when F1.1.1 ≠ RCOM1]	*Print Auto Print SICS Toledo Continuous
F4.1.2		Format [Only available when F4.1.1 =Print or Auto print, and F1.1.1 ≠ RCOM1]	
F4.1.2.1		Line Format	*Multi-line Single-line
F4.1.2.2		Print Language	*English Chinese
F4.1.2.3		Add Line Feed	0,1,2, *3 ,4,5,6,7,8,9

	F-Code	Descriptive Name	Selections and Values
F4 - Communication	F4.1.2.4	Auto Print Threshold [Only available when F4.1.1=Auto print]	*0 - full capacity
	F4.1.2.5	Auto Print reset threshold [Only available when F4.1.1=Auto print]	*0 - full capacity
	F4.1.3	Parameters	
	F4.1.3.1	Baud rate	1200 2400 4800 *9600 19200 38400 57600 115200
	F4.1.3.2	Data Bits / Parity	7 odd 7 even *8 none
	F4.1.3.3	Flow Control	*Off On
	F4.1.4	Checksum [Only available when F4.1.1=Toledo Continuous]	*Off On
	F4.x.10	COM1 Block Reset [Per port, by number]	
	F4.2	COM2/USB [Visible only when option installed]	
	F4.2.1	Connection Mode [Only available when F1.1.1 ≠ RCOM2]	*Print Auto Print SICS Toledo Continuous
	F4.2.2	Format [Only available when F4.2.1 =Print or Auto print, and F1.8.1 ≠ Com 2]	
	F4.2.2.1	Line Format	*Multi-line Single-line
	F4.2.2.2	Print Language	*English Chinese
	F4.2.2.3	Add Line Feed	0,1,2, *3 ,4,5,6,7,8,9

	F-Code	Descriptive Name	Selections and Values
F4- Communication	F4.2.2.4	Auto Print Threshold [only available when F4.2.1=Auto print]	*0 - full capacity
	F4.2.2.5	Auto Print reset threshold [only available when F4.2.1=Auto print]	*0 - full capacity
	F4.2.3	Port Parameters	
	F4.2.3.1	Baud rate	1200 2400 4800 *9600 19200 38400 57600 115200
	F4.2.3.2	Data Bits / Parity	7 odd 7 even *8 none
	F4.2.3.3	Flow Control	*Off On
	F4.2.3.4	RS type [Only available on Com 2]	*RS232 RS422 RS485
	F4.2.3.5	Net Address	*0, 1, 2, 3, 4, 5, 6, 7, 8, 9
	F4.2.3.6	Net address [Only available for RS4xx]	*Off, 0, 1, 2, ..., 9
	F4.2.4	Checksum [Only available when F4.2.1=Toledo Continuous]	*Off On
	F4.2.10	COM2 Block Reset	
F5 - Maintenance	F5.1	Calibration Values	
	F5.1.1	Zero count	xxxxxxx
	F5.1.2	Load 1 weight [half capacity]	xxxxxxx
	F5.1.3	Load 1 count [half capacity]	xxxxxxx
	F5.1.4	Load 2 weight [full capacity]	xxxxxxx
	F5.1.5	Load 2 count [full capacity]	xxxxxxx
	F5.2	Statistics	

F-Code	Descriptive Name	Selections and Values
F5.2.1	Number of Weighs	xxxxxxx
F5.2.2	Number of Overloads	xxxxxxx
F5.2.3	Peak Weight Value	xxxxxxx
F5.2.4	Number of Zero Commands	xxxxxxx
F5.2.5	Number of Zero Failures	xxxxxxx
F5.2.6	Number of Charge Cycles	xxxxxxx
F5.3	Keyboard Test	
F5.4	Display Test	
F5.5	Serial Test	
F5.5.1	COM1 Test	xx xx [Range :00~99]
F5.6	DIO Test [Visible only when option installed]	
F5.6.1	Input 1	On/Off
F5.6.2	Input 2	On/Off
F5.6.3	Output 1	On/Off
F5.6.4	Output 2	On/Off
F5.6.5	Output 3	On/Off
F5.6.6	Output 4	On/Off
F5.7	Raw Counts	xxxxxxx
F5.8	Print Configuration	
F5.10	Reset All	

B Communications

B.1. Serial Interface Parameters

This appendix covers

- Serial Interface Parameters
- Demand Output Mode
- Continuous Output Mode
- CTPZ
- Standard Interface Command Set (SICS) Protocol.

The IND231/IND236 terminal supports one standard serial port and one optional serial port. These are designated COM1 (standard port on the Main PCB) and COM2 (optional).

COM1 provides an RS-232 interface only. The RS-232 interface is a three-wire (TxD, RxD, and GND) with selectable XON-XOFF handshaking.

Optional **COM2** provides RS-232 and RS-422/485 interfaces. The RS-232 interface is a three-wire (TxD, RxD, and GND) with selectable XON-XOFF handshaking. The RS-485 connection is a two-wire interface and supports multi-drop communication with addressing. The port must be configured in setup for use as either RS-232 or RS-485 due to the different operating requirements of the interfaces.

Character framing is programmable in the setup mode. Framing can be:

- 1 start bit
- 7 or 8 ASCII data bits (selectable)
- 0 or 1 parity bit (selectable as none, even, or odd)
- 1 stop bit

The baud rate can be configured from 1200 to 115.2K baud and a checksum character can also be configured when using the continuous output string.

The IND231/IND236 terminal serial ports support the following functions:

- Print output with CTPZ input
- Continuous output with CTPZ input
- SICS (level 0 and level 1)

B.2. Demand Output Mode

The print output mode transmits data only when the terminal receives a print request. Print requests are sent to the IND231/IND236 terminal when:

- The operator presses PRINT
- A discrete input configured as print is triggered

- An ASCII "P" is sent through a demand or continuous port
- Auto print is enabled and all conditions for auto print are met

When triggered, data is transmitted in a string programmed in the output template portion of setup. Print mode is used typically when sending data to a printer or PC on a transactional basis.

- When the print output mode is assigned, the port is automatically set up to also receive certain ASCII characters to duplicate keypad functions. Refer to the C,T,P,Z section later in this appendix for more details.

B.2.1. Output Templates

The IND231/IND236 terminal provides five formats to define the string of data to be transmitted and printed. The print template used is determined by which application is active. Print settings are further explained in the **Communication** section of Chapter 3, **Configuration**.

B.2.1.1. Standard Print Format

The multi-line output looks like:

- A star symbol before the weight will be shown to indicate the weight is average weight if current mode is animal weighing.

Date	YYYY.MM.DD
Time	HH:MM:SS
Gross	XX.XXX Unit
Tare	XX.XXX Unit
Net	XX.XXX Unit

Single-line output looks like (8 characters per number including "."):

```
Date_YYYY.MM.DD_ Time_HH :MM :SS_ Gross_XXXX.XXX_Unit_ Tare_XXXX.XXX_Unit_
Net_XXXX.XXX_Unit
```

B.2.1.2. Over/Under Printout

The multi-line output looks like:

Date	YYYY.MM.DD
Time	HH:MM:SS
Target	XXXX.XXX Unit
Tol+	XX Unit
Tol-	XX Unit
Gross	XXXX.XXX Unit
Tare	XXXX.XXX Unit
Net	XXXX.XXX Unit

Single-line output looks like:

Date_YYYY.MM.DD_ Time_HH :MM :SS_ Target _XXXX.XXX_Unit_ Tol+_ XXXX.XXX_Unit_ Tol-_ XXXX.XXX_Unit_ Gross _XXXX.XXX_Unit_ Tare _XXX.XXX_Unit_ Net_XXXX.XXX_Unit

B.2.1.3. Counting Printout

The multi-line output looks like:

Date	YYYY.MM.DD
Time	HH:MM:SS
Pieces	XXXXXXXXX PCS
APW	XXX.XXX Unit
Tol-	XX Unit
Gross	XXXX.XXX Unit
Tare	XXXX.XXX Unit
Net	XXXX.XXX Unit

Single-line output looks like:

Date_YYYY.MM.DD_ Time_HH :MM :SS_ Pieces_XXXXXXXXX_PCS_ APW _XXX.XXX_Unit_ Gross_XXXX.XXX_Unit_ Tare _XXX.XXX_Unit_ Net_XXXX.XXX_Unit

B.2.1.4. Accumulate Printout

The multi-line output looks like:

Date	YYYY.MM.DD
Time	HH:MM:SS
Total	XX.XXX Unit
Count	XX.XXX
Gross	XXXX.XXX Unit
Tare	XXXX.XXX Unit
Net	XXXX.XXX Unit

Single-line output looks like:

Date_YYYY.MM.DD_ Time_HH :MM :SS_ Total_XXXX.XXX_Unit_ Count_XXXX.XXX_
 Gross_XXXX.XXX_Unit_ Tare_XXX.XXX_Unit_ Net_XXXX.XXX_Unit

B.2.1.5. Animal Printout

The multi-line output looks like:

Date	YYYY.MM.DD
Time	HH:MM:SS
Ave. G	XX.XXX Unit
Tare	XX.XXX Unit
Ave. N	XX.XXX Unit

Single-line output looks like:

Date_YYYY.MM.DD_ Time_HH :MM :SS_ Average G_XXXX.XXX_Unit_ Tare_XXXX.XXX_Unit_
 Average N_XXXX.XXX_Unit

B.3. Continuous Output Mode

The continuous output mode of the IND231/IND236 terminal can be used to continuously send weight data and scale status information to a remote device such as a PC or a remote display including an IND231 or IND236 terminal.

- **NOTE:** When the continuous output mode is assigned, the port is automatically set up to also receive certain ASCII characters to duplicate keypad functions. Refer to the C,T,P,Z section later in this appendix for more details.

B.3.1. Standard Continuous Output

Continuous Output can be assigned to COM1 or COM2. A checksum character can be enabled or disabled with continuous output. A data string will be output approximately 20 times per second for baud rates above 4800 baud. If a baud rate below 4800 is selected, the output rate will be slower. At 300 baud, the output rate is only approximately 1 per second. The data consists of 17 or 18 bytes, as shown in Table B-1.

Non-significant weight data and tare data digits are transmitted as spaces. The continuous output mode provides compatibility with METTLER TOLEDO products that require real-time weight data. Table B-1 shows the format for the standard continuous output.

Table B-1: Standard Continuous Output Format

Character	Status ²				Indicated Weight ³					Tare Weight ⁴								
	1	2	3	4	5	6	7	8	9	10	11	12	13	14	15	16	17	18
Data	STX ¹	SB-A	SB-B	SB-C	MSD	-	-	-	-	LSD	MSD	-	-	-	-	LSD	CR ⁵	CHK ⁶

Continuous Output Format Notes

1. ASCII Start of Text character (02 hex), always transmitted.
2. Status bytes A, B and C. Refer to Table B-2, Table B-3 and Table B-4 for details of the structure.
3. Displayed weight, either gross or net. Six digits, no decimal point or sign. Insignificant leading zeroes are replaced with spaces.
4. Tare weight. Six digits of tare weight data. No decimal point in field.
5. ASCII Carriage Return <CR> character (0D hex).
6. Checksum, transmitted only if enabled in setup. Checksum is used to detect errors in the transmission of data. Checksum is defined as the 2's complement of the seven low order bits of the binary sum of all characters preceding the checksum character, including the <STX> and <CR> characters.

Table B-2, Table B-3 and Table B-4 detail the status bytes for standard continuous output.

Table B-2: Status Byte A Bit Definitions

Bits 2, 1, and 0			
2	1	0	Decimal Point Location
0	0	0	XXXXX00
0	0	1	XXXXX0
0	1	0	XXXXXX
0	1	1	XXXXX.X
1	0	0	XXXX.XX
1	0	1	XXX.XXX
1	1	0	XX.XXXX
1	1	1	X.XXXXX

Bits 4 and 3		
4	3	Build Code
0	1	X1
1	0	X2
1	1	X5
Bit 5		Always = 1
Bit 6		Always = 0

Table B-3: Status Byte B Bit Definitions

Status Bits	Function
Bit 0	Gross = 0, Net = 1
Bit 1	Sign, Positive = 0, Negative = 1
Bit 2	Out of Range = 1 (Over capacity or Under Zero)
Bit 3	Motion = 1, Stable = 0
Bit 4	lb = 0, kg = 1 (see also Status Byte C, bits 0, 1, 2)
Bit 5	Always = 1
Bit 6	Zero Not Captured after power-up = 1

Table B-4: Status Byte C Bit Definitions

Bits 2, 1, and 0			Weight Description
2	1	0	
0	0	0	lb or kg, selected by Status Byte B, bit 4
0	0	1	grams (g)
0	1	0	not used
0	1	1	ounces (oz)
1	0	0	not used
1	0	1	not used
1	1	1	not used
1	1	1	no units

Bits 2, 1, and 0			Weight Description
2	1	0	
Bit 3			Print Request = 1
Bit 4			Expand Data x 10 = 1, Normal = 0
Bit 5			Always = 1
Bit 6			Always = 0

B.4. CTPZ

When a serial port is programmed as a print, continuous output, the CTPZ input mode is automatically assigned. The CTPZ input mode provides a method for a remote serial device to trigger several basic functions when a command character is sent to the terminal. A termination character is not required. Remote ASCII command characters include:

- **C** – Clears the scale to gross
- **T** – Tares the scale (causes a pushbutton tare)
- **P** – Initiates a print command
- **Z** – Zeros the scale
- **S** – Switches units

ASCII command characters must be sent in upper-case letters. All other characters are ignored.

- Note: Some IND231/IND236 applications have additional serial commands. These are described in the application details in the Application chapter.

Example

To initiate a pushbutton tare, program the terminal for print or continuous output for a specific port, program the serial port parameters to match the other device and then send the ASCII character "T".

B.5. Standard Interface Command Set (SICS) Protocol

The IND231/IND236 terminal supports the METTLER TOLEDO Standard Interface Command Set (MT-SICS), which is divided into four levels (0, 1, 2, 3), depending on the functionality of the device. This terminal supports parts of levels 0 and 1:

- MT-SICS level 0 Command set for the simplest device.
- MT-SICS level 1 Extension of the command set for standard devices.
- MT-SICS level 2 Extension of the command set by the commands specific for a scale family.
- MT-SICS level 3 Extension of the command set by commands specific for a certain application of scale family.

A feature of this interface is that the commands combined in MT-SICS level 0 and 1 are identical for all devices. Both the simplest weighing device and a fully expanded weighing workstation can recognize the commands of MT-SICS levels 0 and 1.

MT-SICS level 0 and level 1 contain the following functions:

- Request Weighting results
- Tare the scale and preset the tare weight
- Zero the scale
- Identify MT-SICS implementation
- Identify the scale
- Reset the scale

B.5.1. Version Number of the MT-SICS

Each level of the MT-SICS has its own version number, which can be requested with the command I1 from level 0. This terminal supports:

- MT-SICS level 0, version 2.2x
- MT-SICS level 1, version 2.2x (except the D, DW and K commands)
- MT-SICS level 2, version 2.2x
- MT-SICS level 3, version 2.2x

B.5.2. Command Formats

Each command received by the terminal via the SICS interface is acknowledged by a response to the transmitting device. Commands and responses are data strings with a fixed format. Commands sent to the terminal comprise one or more characters of the ASCII character set. Commands must be in upper-case.

The parameters of the command must be separated from one another and from the command name by a space (ASCII 32 dec). In the examples shown in this section, a space is represented as

—

Each command must be terminated by <CR><LF> (ASCII 13 dec., ASCII 10 dec.).

SI	SP	C _R	L _F
----	----	----------------	----------------

- SI ASCII Command, 1-2 Bytes, must be capital letters
- SP Space (ASCII 32 dec.).
- C_R Carriage Return (ASCII 13 dec.).
- L_F Line Feed (ASCII 10 dec.).

The characters <CR> and <LF>, which can be input using the ENTER or RETURN key of most PC terminal keypads, are not shown in this description; however, it is essential they be included for communication with the terminal.

Example

Command to tare the terminal:

"TA_20.00_lb" (The command terminators <CR><LF> are not shown.)

B.5.3. Response Formats

All responses sent by the terminal to the transmitting device acknowledging the received commands have one of the following formats:

- Response with weight value
- Response without weight value
- Error message

B.5.3.1. Format of the Response with Weight Value

A general description of the response with weight value as follows:

ID	—	Status	—	Weight Value	—	Unit	C _R	L _F
1-2		1		10		1-3		
characters		character		characters		characters		
ID								
Status								
Weight Value								
Unit								
CR								
LF								

Comment

The <CR> and <LF> characters will not be shown in the descriptions below.

Examplef

Response with a stable weight value of 0.256 kg:

S _ S _ _ _ _ _ 0.256 _ kg

B.5.3.2. Format of the Response without Weight Value

A general description of the response without weight value is as follows:

B.5.4.3. Quotation Marks (“ ”)

Quotation marks included in the command responses are used to designate fields and will always be sent.

B.5.5. Commands and Responses MT-SICS Level 0

The terminal receives a command from the system computer and acknowledges the command with an appropriate response. The following sections contain a detailed description of the command set, arranged in alphabetical order and including the associated responses. Commands and responses are terminated with <CR> and <LF>. These termination characters are not shown in the following description, but they must always be entered with commands or sent with responses.

The following MT-SICS level 0 commands are supported:

- I0 Inquiry the list of all implemented MT-SICS commands
- I1 Inquiry of MT-SICS level And MT-SICS versions
- I2 Inquiry of scale data
- I3 Inquiry of scale software version and type definition number
- I4 Inquiry of serial number
- S Send stable weight value
- SI Send weight value immediately
- SIR Send weight value immediately and repeat
- Z Zero the scale when stable
- ZI Zero the scale immediately irrespective of stability
- @ Reset

The following are detailed descriptions of these Level 0 commands:

B.5.5.1. IO – INQUIRY OF ALL IMPLEMENTED MT-SICS COMMANDS

Command: I0

Response:

IO_B_0_“I0”	Level 0 “I0” command implemented
IO_B_0_“I1”	Level 0 “I1” command implemented
IO_B_0_“I2”	Level 0 “I2” command implemented
IO_B_0_“I3”	Level 0 “I3” command implemented
IO_B_0_“I4”	Level 0 “I4” command implemented
IO_B_0_“S”	Level 0 “S” command implemented
IO_B_0_“SI”	Level 0 “SI” command implemented
IO_B_0_“SIR”	Level 0 “SIR” command implemented
IO_B_0_“Z”	Level 0 “Z” command implemented

IO_B_0_"ZI"	Level 0 "ZI" command implemented
IO_B_0_"@"	Level 0 "@" command implemented
IO_B_1_"T"	Level 1 "T" command implemented
IO_B_1_"TAC"	Level 1 "TAC" command implemented
IO_B_1_"TA"	Level 1 "TA" command implemented
IO_B_1_"TI"	Level 1 "TI" command implemented
IO_B_2_"PRN"	Level 1 "PRN" command implemented
IO_B_2_"SIH"	Level 1 "SIH" command implemented
IO_B_3_"DAT"	Level 1 "DAT" command implemented
IO_A_3_"TIM"	Level 1 "TIM" command implemented

Response: IO_I Cannot execute command at this time.

B.5.5.2. I1 – INQUIRY OF MT-SICS LEVEL AND MT-SICS VERSIONS

Command: I1

Response: I1_A_"0123"_"2.20"_"2.20"_"2.20"_"2.20"

"0123"	IND231 supports levels 0 to 3
2.20	Level 0, version V2.2x
2.20	Level 1, version V2.2x
2.20	Level 2, version V2.2x
2.20	Level 3, version V2.2x

Response: I1_I Command understood, not executable at present.

Comments

For the MT-SICS level, only fully implemented levels are listed. In this case, neither level 0 nor level 1 was fully implemented, so the level is not specified.

In the case of the MT-SICS version, all levels are specified even those only partially implemented.

B.5.5.3. I2 – INQUIRY OF DATA

Command: I2

Response: I2_A_"IND231/IND236_XXyy" (XX = capacity of the terminal, yy = primary units)

IND231/IND236	Model number of terminal
XXyy	Capacity and primary unit of the scale

Response: I2_I Command understood, not executable at present.

Comment

The number of characters in the "text" field depends on the scale capacity.

B.5.5.4. I3 – INQUIRY OF SOFTWARE VERSION

Command: I3
Response: I3_A_“30047226 01.00.00”
30047226 BOM of the terminal
01.00.00 Firmware version of the terminal
Response: I3_I Command understood, not executable at present.

Comment

The number of characters of “text” depends on the revision level.

B.5.5.5. I4 – INQUIRY OF SERIAL NUMBER

Command: I4
Response: I4_A_“123456”
123456 Serial number of terminal
Response: I4_I Command understood, not executable at present.

B.5.5.6. S – SEND STABLE WEIGHT VALUE

Command: S
Response: S_S_ _ _ _ 436.2_lb
436.2 stable displayed weight
lb weight unit
Response: S_I Command understood, not executable at present.
Response: S_+ Terminal in overload range.
Response: S_- Terminal in underload range.

Comment

The terminal will wait for up to 3 seconds after receiving an “S” command for no-motion. If motion does not settle within this time, the command is aborted and the S_I response is sent.

B.5.5.7. SI – SEND WEIGHT VALUE IMMEDIATELY

Command: SI
Response: S_S_ _ _ _ 436.2_lb Stable weight value.
Response: S_D_ _ _ _ 436.2_lb Non-stable (dynamic) weight value.
Response: S_I Command understood, not executable at present.
Response: S_+ Terminal in overload range.
Response: S_- Terminal in underload range.

Comment

The response to the command SI is the last internal weight value (stable or dynamic) before receipt of the "SI" command.

B.5.5.8.**SIR – SEND WEIGHT VALUE IMMEDIATELY AND REPEAT**

Command: SIR

Response: S_S_ _ _ _ _ 436.2_lb Stable weight value.

Response: S_D_ _ _ _ _ 436.2_lb Non-stable (dynamic) weight value.

Response: S_I Command understood, not executable at present.

Response: S_+ Terminal in overload range.

Response: S_- Terminal in underload range

Example

Command: SIR

Response: S_D_ _ _ _ _ 129.07_kg

S_D_ _ _ _ _ 129.09_kg

S_S_ _ _ _ _ 129.09_kg

S_S_ _ _ _ _ 129.09_kg

S_D_ _ _ _ _ 114.87_kg

. . . The scale continues to send stable or dynamic weight values

Comments

The SIR command is overwritten and cancelled by the commands S, SI, SR, @ and hardware break and hence cancelled.

The data output rate is approximately 4 per second.

B.5.5.9.**Z – ZERO**

Command: Z

Response: Z_A Command performed, meaning the scale was in gross mode, scale was stable and weight was within the zero capture range.

Response: Z_I Command understood, not executable at present.

Response: Z_+ Upper limit of zero setting range exceeded.

Response: Z_- Lower limit of zero setting range exceeded.

Comments

The calibrated zero point determined during calibration is not influenced by this command.

The terminal will wait for up to 3 seconds after receiving an "Z" command for no-motion. If motion does not settle within this time, the command is aborted and the Z_I response is sent.

B.5.5.10. ZI – Zero the scale immediately irrespective of stability

Command: ZI
Response: ZI D Zero setting performed under dynamic conditions
 ZI S Zero setting performed under stable conditions
 ZI Zero setting not performed
 ZI+ Upper limit of zero setting range exceeded
 ZI- Lower limit of zero setting range exceeded

Comments

Terminal always responds Z I, if OIML or NTEP is approved.

B.5.5.11. @ – RESET

Command: @
Response: I4_A_ "12345678"
 "12345678" Serial number of the scale, the scale is ready for operation

Comments

Resets the scale to the condition found after switching on, but without a zero setting being performed.

Cancels all commands that are awaiting responses.

Clears the tare register.

Cancels the SIR and SR commands.

The Reset command is always executed **except** when the command is received by the terminal during the calibration and test procedure. In this case, the Reset command cannot be processed.

B.5.6. Commands and Responses MT-SICS Level 1

The following commands of MT-SICS level 1 are available:

SR Send weight value on weight change (send and repeat)
T Tare
TA Pre-Tare
TAC Clear tare value
TI Tare Immediately

B.5.6.1.

SR – SEND WEIGHT VALUE ON WEIGHT CHANGE (SEND AND REPEAT)

Command:	SR_PresetValue_Unit	Send the current stable weight value and then continuously after every weight change greater or equal to the preset value a non-stable value followed by the next stable value, range = 1d to maximum load. If no preset value is entered, the weight change must be at least 12.5% of the last stable weight value, minimum = 30d.
Response:	S_S_WeightValue_Unit	Current, stable weight value. Weight change.
Response:	S_D_WeightValue_Unit	Non-stable weight value.
Response:	S_S_WeightValue_Unit	Next stable weight value.
Response:	S_I	Command understood, not executable at present.
Response:	S_L	The command is not executable.
Response:	S_+	Terminal in overload range.
Response:	S_-	Terminal in underload range.

Example

Command:	SR_0.50_kg	Send the current stable weight value followed by every load change ≥ 0.50 kg.
Response:	S_S_ _ _ _ _100.00_kg	Scale stable.
	S_D_ _ _ _ _115.23_kg	More than 0.50 kg loaded.
	S_S_ _ _ _ _200.00_kg	Scale again stable.

Comments

SR is overwritten and cancelled by the commands S, SI, SIR, @ and hardware break.

If, following a non-stable weight value, stability has not been reached within the timeout interval, the response "S_I" is sent and then a non-stable weight value. Timeout then starts again from the beginning.

The preset value must be entered in the first unit that is the weight unit displayed after the terminal has been switched on.

B.5.6.2.

T – TARE

Command:	T	
Response:	T_S_ _ _ _100.00_kg	Tare performed, meaning the scale was stable and weight was within the weighing range.
Response:	T_I	Command understood, not executable at present.
Response:	T_+	Upper limit of tare setting range exceeded.
Response:	T_-	Lower limit of tare setting range exceeded.

Comments

The existing tare will be overwritten and replaced by the new preset tare weight value.

The terminal will wait for up to 3 seconds after receiving a "T" command for no-motion. If motion does not settle within this time, the command is aborted and the T_I response is sent.

B.5.6.3. TA – Inquiry/presetting of tare weight value

Inquiry:

Command:	TA	Inquiry of current tare value
Response:	TA A	Tare Value Unit
		Current tare weight value in displayed unit
	TA I	Command not executable

Setting:

Command:	TA A	Tare Value Unit
		Entry of a tare preset value in displayed unit
Response:	TA A	Weight Value Unit
		Taring performed with the preset tare value in displayed unit
	TA I	Taring not performed
	TA L	Command understood, parameter wrong

Example

Command:	TA 100.00 g	
Response:	TA_A_____100.00 g	The scale has 100.00g in the tare memory

Comments

The tare memory will be overwritten by the preset tare weight value.

The keyed in tare value will be automatically rounded by the scale to the current readability.

The preset value must be entered in the current unit.

The taring range is specified to the scale type.

B.5.6.4. TAC – CLEAR TARE VALUE

Command:	TAC	
Response:	TAC_A	Tare value cleared.
Response:	TAC_I	Command understood, not executable at present.

B.5.6.5. TI – TARE IMMEDIATELY

Command:	TI	
Response:	TI_S_WeightValue_Unit	Taring performed, stable tare value.
Response:	TI_D_WeightValue_Unit	Taring performed, non-stable (dynamic) tare value.

Response:	TI_I	Command understood, not executable at present.
Response:	TI_L	The command is not executable.
Response:	TI_+	Upper limit of taring range exceeded.
Response:	TI_-	Lower limit of taring range exceeded.

Example

Command:	TI	
Response:	TI_D_ _ _ _ 117.57_kg	Tare taken with dynamic weight value.

Comments

Any previous tare value will be overwritten by the new tare weight value.
 Tare weight values determined during motion may not be accurate.
 The tare weight value is sent in the current units.

B.5.7. Commands and Responses MT-SICS Level 2

The following commands of MT-SICS level 2 are available:

PRN	Printout
SIH	High resolution weight

B.5.7.1. PRN – Start printout

Command:	PRN	Start printout on printer channel
Response	PRN A	Command executed
	PRIN-I	Command not executable at present

B.5.7.2. SIH

Command:	PRN	Send the weight in high resolution immediately
Response	H S WeightValue Unit	Stable net weight in high resolution in current unit
	H D WeightValue Unit	Dynamic net weight in high resolution in current unit

Example

Command:	SIH	
Response:	H_S_ _ _ 1.99982_kg	Current net weight in high resolution is 1.99982 kg and stable.

B.5.8. Commands and Responses MT-SICS Level 3

The following commands of MT-SICS level 3 are available:

DAT	Date
TIM	Time

B.5.8.1. DAT – Inquiry and setting of date

Inquiry:

Command: DAT Inquiry of current date of the scale

Response: DAT A dd mm yyyy

DAT I Command not executable

Setting:

Command: DAT dd mm yyyy

Response: DAT A Date has been set

DAT I Date cannot be set at present

DAT L Command not executed as date format is not correct

B.5.8.2. TIM – Inquiry and setting of time

Inquiry:

Command: TIM Inquiry of current time of the scale

Response: TIM A hh mm ss Represent time in the format hours minutes seconds

TIM I Inquiry of time not possible

Setting:

Command: TIM hh mm ss Set time in 24-hour-format

Response: TIM A Time has been set, clock running

TIM I The time cannot be set at present

TIM L Command not executed as time format is not correct

C GEO Codes

This appendix covers

- Original Site Calibration
- New Site GEO Code Adjustment

The GEO code feature provided in the IND231/236 terminal permits calibration readjustment due to changes in elevation or latitude without reapplying test weights. This adjustment assumes a previously accurate calibration was done with the GEO code set properly for that original location and that the GEO code for the new location can be accurately determined. The procedure for using this feature is as follows.

C.1. Original Site Calibration

1. Use the GEO code chart (Table C-1) on the following pages to determine the GEO code for the current altitude and location at which the scale will be calibrated.
2. Enter that GEO value into the GEO code parameter in setup at **Scale > Calibration**.
3. Immediately after entering the GEO code, perform a zero and span adjustment using accurate test weights.
4. Exit the setup menu tree.
5. The scale can now be used in its new location.

C.2. New Site GEO Code Adjustment

When a terminal is to be reinstalled at a different geographic location, gravitational and altitude changes can be accounted for by following these steps. Note that this procedure is not necessary if an on-site recalibration is performed.

1. Use the GEO code chart (Table C-1) on the following pages to determine the GEO code for the new altitude and location at which the scale will be used.
2. Enter that GEO value into the GEO code parameter in Setup at Scale > Calibration.
3. Immediately after entering the GEO code, exit the setup menu tree. DO NOT perform a normal calibration.

The calibration has now been adjusted for the differences in gravity from the original site of calibration to the new site of use.

Using the GEO code value for calibration adjustment is not as accurate as re-applying certified test weights and re-calibrating the scale in a new location.

Table C-1: GEO Adjustment Values

Latitude North or South, in Degrees and Minutes	Height Above Sea Level, in Meters										
	0	325	650	975	1300	1625	1950	2275	2600	2925	3250
	325	650	975	1300	1625	1950	2275	2600	2925	3250	3575
	Height Above Sea Level, in Feet										
	0	1060	2130	3200	4260	5330	6400	7460	8530	9600	10660
1060	2130	3200	4260	5330	6400	7460	8530	9600	10660	11730	
0° 0'–5° 46'	5	4	4	3	3	2	2	1	1	0	0
5° 46'–9° 52'	5	5	4	4	3	3	2	2	1	1	0
9° 52'–12° 44'	6	5	5	4	4	3	3	2	2	1	1
12° 44'–15° 6'	6	6	5	5	4	4	3	3	2	2	1
15° 6'–17° 0'	7	6	6	5	5	4	4	3	3	2	2
17° 10'–19° 2'	7	7	6	6	5	5	4	4	3	3	2
19° 2'–20° 45'	8	7	7	6	6	5	5	4	4	3	3
20° 45'–22° 22'	8	8	7	7	6	6	5	5	4	4	3
22° 22'–23° 54'	9	8	8	7	7	6	6	5	5	4	4
23° 54'–25° 21'	9	9	8	8	7	7	6	6	5	5	4
25° 21'–26° 45'	10	9	9	8	8	7	7	6	6	5	5
26° 45'–28° 6'	10	10	9	9	8	8	7	7	6	6	5
28° 6'–29° 25'	11	10	10	9	9	8	8	7	7	6	6
29° 25'–30° 41'	11	11	10	10	9	9	8	8	7	7	6
30° 41'–31° 56'	12	11	11	10	10	9	9	8	8	7	7
31° 56'–33° 9'	12	12	11	11	10	10	9	9	8	8	7
33° 9'–34° 21'	13	12	12	11	11	10	10	9	9	8	8
34° 21'–35° 31'	13	13	12	12	11	11	10	10	9	9	8
35° 31'–36° 41'	14	13	13	12	12	11	11	10	10	9	9
36° 41'–37° 50'	14	14	13	13	12	12	11	11	10	10	9
37° 50'–38° 58'	15	14	14	13	13	12	12	11	11	10	10
38° 58'–40° 5'	15	15	14	14	13	13	12	12	11	11	10
40° 5'–41° 12'	16	15	15	14	14	13	13	12	12	11	11
41° 12'–42° 19'	16	16	15	15	14	14	13	13	12	12	11
42° 19'–43° 26'	17	16	16	15	15	14	14	13	13	12	12
43° 26'–44° 32'	17	17	16	16	15	15	14	14	13	13	12
44° 32'–45° 38'	18	17	17	16	16	15	15	14	14	13	13

Latitude North or South, in Degrees and Minutes	Height Above Sea Level, in Meters										
	0	325	650	975	1300	1625	1950	2275	2600	2925	3250
	325	650	975	1300	1625	1950	2275	2600	2925	3250	3575
	Height Above Sea Level, in Feet										
	0	1060	2130	3200	4260	5330	6400	7460	8530	9600	10660
1060	2130	3200	4260	5330	6400	7460	8530	9600	10660	11730	
45° 38'–46° 45'	18	18	17	17	16	16	15	15	14	14	13
46° 45'–47° 51'	19	18	18	17	17	16	16	15	15	14	14
47° 51'–48° 58'	19	19	18	18	17	17	16	16	15	15	14
48° 58'–50° 6'	20	19	19	18	18	17	17	16	16	15	15
50° 6'–51° 13'	20	20	19	19	18	18	17	17	16	16	15
51° 13'–52° 22'	21	20	20	19	19	18	18	17	17	16	16
52° 22'–53° 31'	21	21	20	20	19	19	18	18	17	17	16
53° 31'–54° 41'	22	21	21	20	20	19	19	18	18	17	17
54° 41'–55° 52'	22	22	21	21	20	20	19	19	18	18	17
55° 52'–57° 4'	23	22	22	21	21	20	20	19	19	18	18
57° 4'–58° 17'	23	23	22	22	21	21	20	20	19	19	18
58° 17'–59° 32'	24	23	23	22	22	21	21	20	20	19	19
59° 32'–60° 49'	24	24	23	23	22	22	21	21	20	20	19
60° 49'–62° 9'	25	24	24	23	23	22	22	21	21	20	20
62° 9'–63° 30'	25	25	24	24	23	23	22	22	21	21	20
63° 30'–64° 55'	26	25	25	24	24	23	23	22	22	21	21
64° 55'–66° 24'	26	26	25	25	24	24	23	23	22	22	21
66° 24'–67° 57'	27	26	26	25	25	24	24	23	23	22	22
67° 57'–69° 35'	27	27	26	26	25	25	24	24	23	23	22
69° 5'–71° 21'	28	27	27	26	26	25	25	24	24	23	23
71° 21'–73° 16'	28	28	27	27	26	26	25	25	24	24	23
73° 16'–75° 24'	29	28	28	27	27	26	26	25	25	24	24
75° 24'–77° 52'	29	29	28	28	27	27	26	26	25	25	24
77° 52'–80° 56'	30	29	29	28	28	27	27	26	26	25	25
80° 56'–85° 45'	30	30	29	29	28	28	27	27	26	26	25
85° 45'–90° 00'	31	30	30	29	29	28	28	27	27	26	26

METTLER TOLEDO Service

To protect your METTLER TOLEDO product's future:

Congratulations on choosing the quality and precision of METTLER TOLEDO. Proper use according to these instructions and regular calibration and maintenance by our factory-trained service team ensure dependable and accurate operation, protecting your investment. Contact us about a METTLER TOLEDO service agreement tailored to your needs and budget.

We invite you to register your product at www.mt.com/productregistration so we can contact you about enhancements, updates and important notifications concerning your product.

www.mt.com/IND231-IND236

For more information

Mettler-Toledo, LLC

1900 Polaris Parkway
Columbus, OH 43240
Phone 800 438 4511
Fax 614 438 4900

© 2014 Mettler-Toledo, LLC
30094013 Rev. 02, 04/2014
Document version B



30094013