

Weighing Kit

WKR / WKL Models

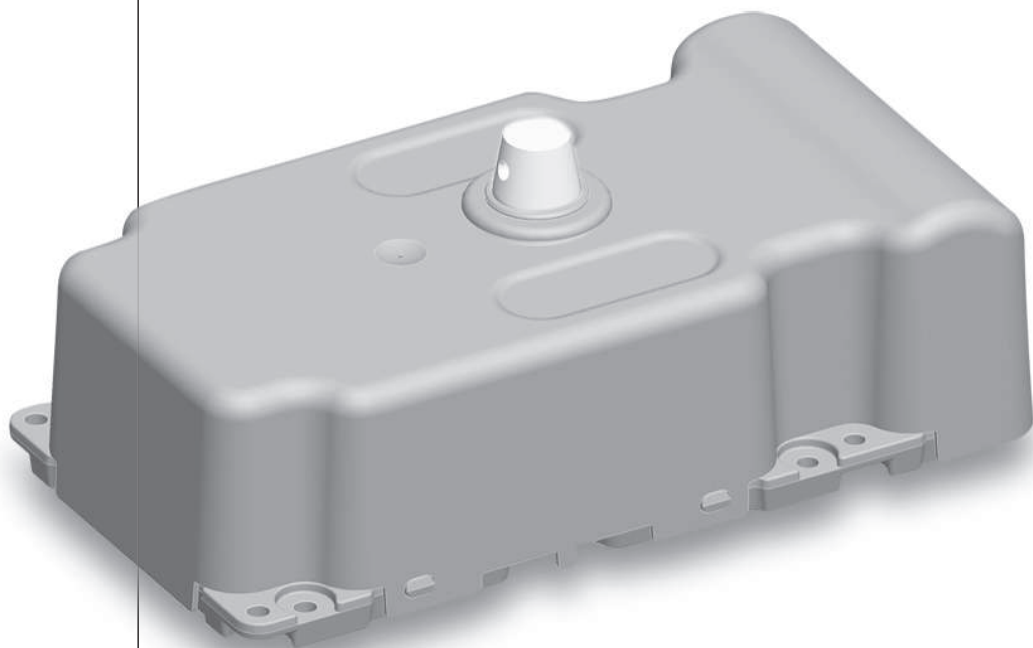

METTLER TOLEDO

Table of Contents

1	Introduction		5
	1.1	Conventions and Symbols Used in These Operating Instructions	5
2	Safety Information		6
	2.1	Definition of Signal Warnings and Symbols	6
	2.2	Product Specific Safety Notes	6
3	Installation and Commissioning		8
	3.1	Scope of Delivery	8
		Unpacking WKR / WKL Weighing Kit	8
	3.2	Selecting the Location	9
	3.3	Leveling	9
	3.4	Installation	10
	3.4.1	Load Cell	10
	3.4.2	Weighing Pan	10
	3.4.3	Electronics	10
	3.4.4	Connecting Load Cell and Electronic PCB	12
4	Configuring the Weighing Kit Before Operation		13
	4.1	Preparation	13
	4.2	Interface and Communications Protocols	13
	4.3	Setting the Readability	13
	4.4	Defining Stability Criteria	14
	4.5	Selecting the Filter Properties Using the Weighing Type	14
	4.6	Setting Filter Damping	15
	4.7	Internal and External Adjustment/Test	15
	4.8	Update Rate for Continuous Weight Transmission	16
	4.9	Programming Tips and Aids	16
	4.9.1	Error Messages	17
5	Weighing Operation Commands and Functions		18
	5.1	Transmission of Weight Value	18
	5.2	Taring Functions	18
	5.3	Reset Functions	18
6	Optional Display with Key Pad		20
	6.1	Operation Keys	20
	6.2	Display Panel	21
	6.3	Menu Settings	21
	6.3.1	Menu Operation	22
	6.3.2	Description of Menu Topics	23
	6.3.2.1	Main Menu	23
	6.3.2.2	Basic Menu	24
	6.3.2.3	Advanced Menu	24
	6.3.2.4	Interface Menu	26
	6.4	Error Messages	29

7	Maintenance		30
	7.1	Cleaning	30
	7.2	Disposal	30
8	Technical Data		31
	8.1	General Data	31
	8.2	Model-specific Data	31
9	Mechanical Dimensions		32
	9.1	Load Cell	32
	9.2	Mainboard	32
	9.3	Connector Board	33
	9.4	Optional Display	33
	9.5	Optional Weighing Pan	33
10	Accessories		34
11	Appendix		35
	11.1	Conversion Table for Weight Units	35
12	Index		36

1 Introduction

Thank you for choosing a METTLER TOLEDO weighing kit. These operating instructions apply to all WKR/WKL models. However, the different models have different characteristics regarding equipment and performance. Special notes in the text indicate where this makes a difference to operation.

1.1 Conventions and Symbols Used in These Operating Instructions

Key designations are indicated by double angular brackets (e.g. «»).



This symbol indicates press key briefly (less than 1.5 s).



This symbol indicates press and hold key down (longer than 1.5 s).



This symbol indicates a flashing display.



This symbol indicates an automatic sequence.



These symbols indicate safety notes and hazard warnings which, if ignored, can cause personal danger to the user, damage to the weighing kit or other equipment, or malfunctioning of the weighing kit.

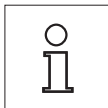

This symbol indicates additional information and notes. These make working with your weighing kit easier, as well as ensuring that you use it correctly and economically.

2 Safety Information

2.1 Definition of Signal Warnings and Symbols

Safety notes are marked with signal words and warning symbols. These show safety issues and warnings. Ignoring the safety notes may lead to personal injury, damage to the instrument, malfunctions and false results.

Signal Words

CAUTION	for a hazardous situation with low risk, resulting in damaged to the device or the property or in losing of data or minor or medium injuries if not avoided.
Attention	(no symbol) for important information about the product.
Note	(no symbol) for useful information about the product.

Warning Symbols



General hazard



Electrical shock



Electrostatic discharge
(ESD)

2.2 Product Specific Safety Notes

General Safety Information

Your instrument meets the state of the art technology and complies with all recognized safety rules, however, certain hazards may arise in extraneous circumstances. Do not open the housing of the instrument: It does not contain any parts which can be maintained, repaired or replaced by the user. If you ever have problems with your instrument, contact your authorized METTLER TOLEDO dealer or service representative.

Always operate and use your instrument only in accordance with the instructions contained in this manual. The instructions for setting up your new instrument must be strictly observed.

If the instrument is not used according to these Operating Instructions, protection of the instrument may be impaired and METTLER TOLEDO assumes no liability.

Intended Use

METTLER TOLEDO Weighing Kits are precision weighing instruments for integration in machines and test equipment. Use the instruments exclusively for this purposes. Any other type of use and operation beyond the limits of technical specifications without written consent from Mettler-Toledo AG, is considered as not intended.



It is not permitted to use the instrument in explosive atmosphere of gases, steam, fog, dust and flammable dust (hazardous environments).

Staff Safety

The protection housing, the Weighing cell and electronics have to handle with absolute care and by authorized people only.

In order to use the instrument, you must have read and understood the operating instructions. Keep the operating instructions for further reference.

Never make any modifications or constructional alterations to the instrument and use only original spare parts and optional equipment from METTLER TOLEDO.

Safety Notes



CAUTION

Risk of damage the instrument

- a) The aluminium base plate should only be removed shortly before installation.
 - b) Do not use sharply pointed objects to operate the optional keyboard of your weighing kit. Although your weighing kit is very ruggedly constructed, it is nevertheless a precision instrument. Treat it with corresponding care.
 - c) Do not remove the protection housing from the WKR / WKL: It does not contain any parts which can be maintained, repaired or replaced by the user. If you ever have problems with your weighing kit, contact your METTLER TOLEDO representative.
-



CAUTION

Risk of damage the instrument

- a) For use with a certified (CSA or equivalent) power supply, which must have a limited and SELV circuit output.
 - b) Use only specified voltage and currency or order universal AC adapter as accessory.
-



CAUTION

Electrostatic discharge (ESD)

Risk of damage electronic components.

- Do not touch electronic components. Use ESD-protection wristband.
-

3 Installation and Commissioning

3.1 Scope of Delivery

Check the completeness of the delivery. The following components are part of the standard equipment of your Weighing Kit.

- WKR or WKL load cell
- Box with electronic parts containing:
 - Mainboard
 - Connector board
- Declaration and reference guide
- CD-ROM

Immediately inform your METTLER TOLEDO representative if you have any complaints or parts are missing.

Unpacking WKR / WKL Weighing Kit

- Unpack the Box and check the content.

Attention

Do not touch electronic parts when opening the box with the electronics. Use an ESD-protection wristband.

Open the box (1) and remove box with electronic parts (2).

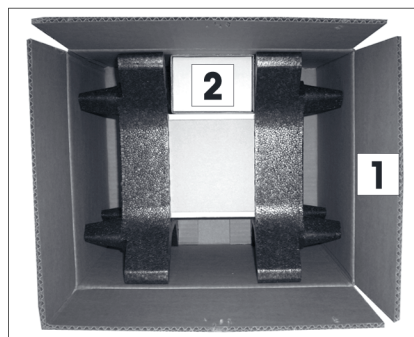

The operating instructions and PC Software for easy commissioning is stored on the CD-ROM. Keep the documentation for later use.



The load cell is packed in the white box. Handle this load cell with care. Keep the packaging for transporting the load cell.

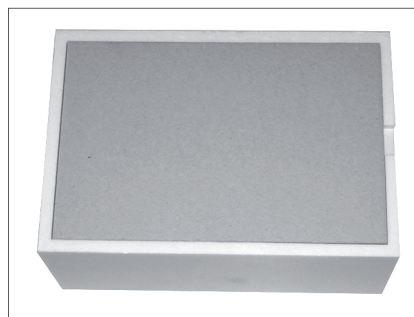

The load cell is fixed on a transport base plate with four M4 screws (torx T20).

The aluminum base plate should only be removed shortly before installation. Use a screddriver (torx T20) to remove the four M4 screws.

Even with the protection housing, the load cell and electronics have to handle with absolute care and by authorized people only.



3.2 Selecting the Location

Select a stable, vibration-free position that is as horizontal as possible. The surface must be able to safely carry the weight of a fully loaded weighing kit.

Observe ambient conditions (see Technical Data).

Avoid the following:

- Vibrations
- Excessive temperature fluctuations
- Direct sunlight
- Powerful drafts (e.g. from fans or air conditioners)

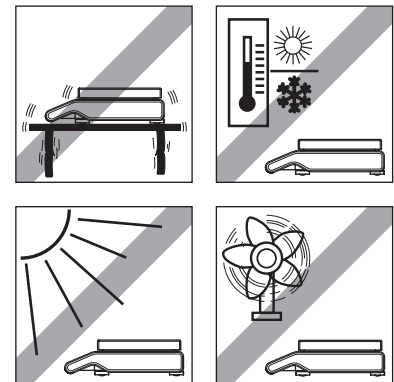

3.3 Leveling

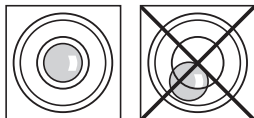

Use a leveling aid to level the weighing kit

Note: The weighing kit should be leveled and adjusted each time it is moved to a new location.

3.4 Installation



CAUTION

Electrostatic discharge (ESD)

Risk of damage electronic components.

- Do not touch electronic components. Use ESD-protection wristband.

Attention

The load cell and the appropriate electronic PCB belong together and must not be exchanged with another kit!

Read carefully operating instructions before you connect the electronic boards and load cell together.

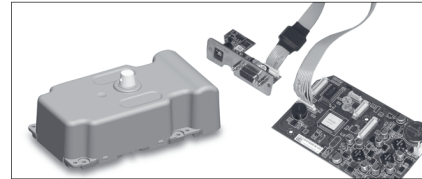

3.4.1 Load Cell

In order to mount the load cell, use four M4 screws (torque 2Nm)
Mount the load cell on a flat surface. The leveling aid (optional) must be aligned with an accuracy of 0.5 per mill to the load cell bearing surfaces of the bottom housing.



3.4.2 Weighing Pan

If a custom made weighing pan is used, adequate dimensions according to the corresponding interface drawings must be ensured.

Whenever possible the load shall be introducing along the centerline of the cone. A maximum offset of 40 mm shall not be exceeded.

For thermal isolation we recommend to use a plastic material. This material must be electrical conductive to not have influences of electrostatic.



3.4.3 Electronics

Mainboard

On the mainboard are three holes for M3 screws to fix it. The board needs spacers or isolation parts to not make contact over a metal part.

Attention

Be aware that the electronics need a housing for protection against electromagnetic compatibility (EMC)



Connector board

The power connector and RS232 interface are located on the connector board. This can be fixed on the connecting plate with two M3 screws.

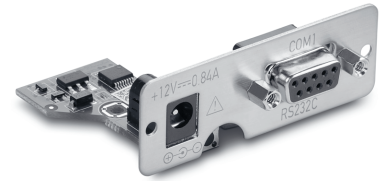

Optional interface

If there is a second RS232 interface installed, use this for the communication and make sure, that in case of service a METTLER TOLEDO service technician can connect the RS232 on the connector board.

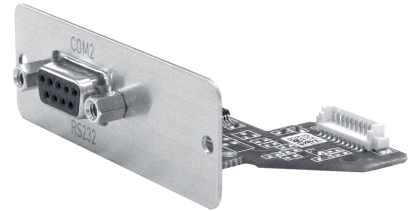

Optional display

The display can be mounted with four M3 screws. If you need a keypad, use the self-adhesive pad.



3.4.4 Connecting Load Cell and Electronic PCB

The cable length between the load cell (1 ~ 150 mm and 2 ~ 280 mm) and main board have the maximum length. Do not extend this cable to avoid influences on the weigh result.

Use the delivered cable with the ferrite cores for connection of the mainboard to the connector board (3 ~ 340 mm).

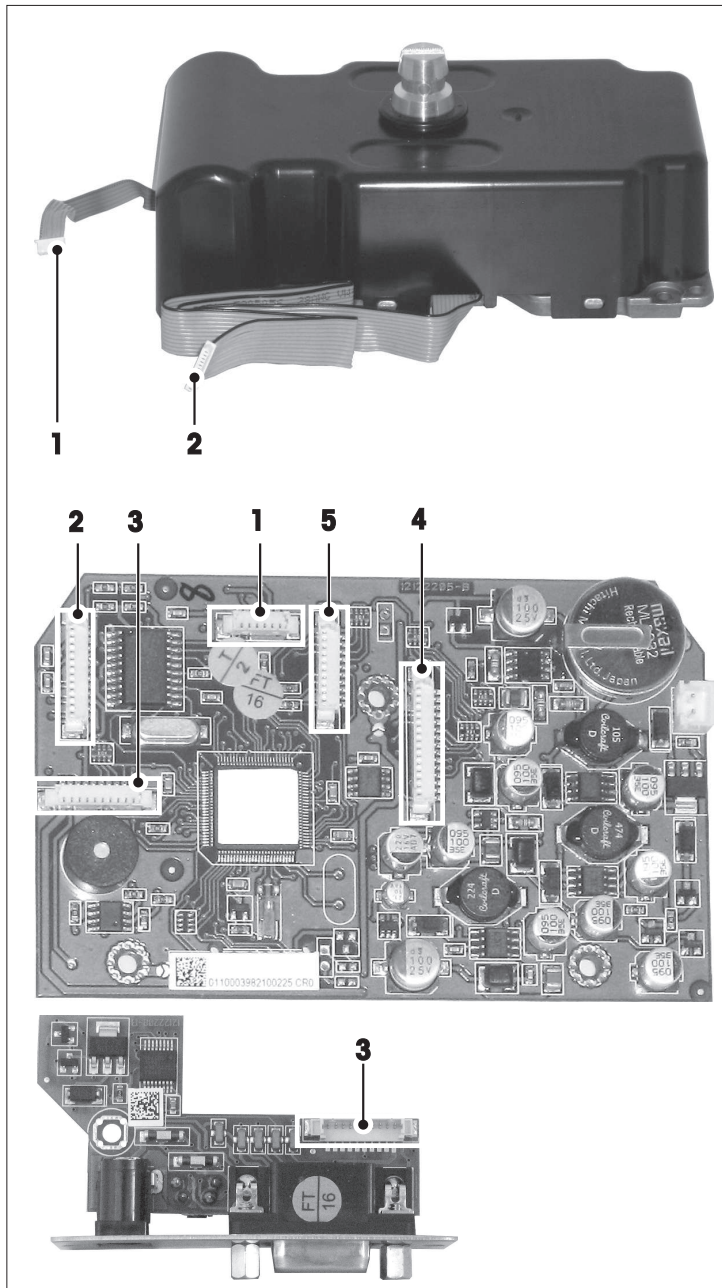

- 1 Internal adjustment (if available)
- 2 Load cell connection
- 3 Power / RS232C connection
- 4 Optional display
- 5 Optional RS232C interface

4 Configuring the Weighing Kit Before Operation

The optimum weighing kit settings for your application depend on the requirements and the environmental conditions. To define these settings, make sure that your weighing kit is correctly connected in accordance with chapter Installation and Commissioning (page 8) and is connected to a computer via RS232 interfaces. You will also need the MT-SICS Reference Manual (1 1781363) which describes the relevant commands in detail.

4.1 Preparation

Before defining the settings on the weighing kit, the following points should be clarified:

- What sort of weighing process is involved (check weighing, dispensing to a specified target weight)?
- What level of precision (expressed in display increments) must be achieved?
- What level of repeatability is required?
- What weighing rate (e.g. 10 per minute) is required?
- How often must the weighing kit be checked/adjusted during operation to meet the precision requirements?
- How heavy is the load supporting device (pre-load)?
- What weight (built-in or external) will be used for checking/adjustment?
- What unit should be used to express the weight set?
- What sort of interference might be present (oscillations, vibrations, air movements, static charges)?
- How will the weighing object be applied?
- What type of weighing object is involved (solid, liquid etc.)?
- To which interface will your system (PC, SPS etc.) be connected?

4.2 Interface and Communications Protocols

The WKR / WKL weighing kit has an RS232 interface and an optional second RS232 interface. The respective parameters for the MT-SICS commands can be found in the MT-SICS Manual (1 1781363).

Note

- that commands affecting the interface or its mode of communication have an immediate effect.
- each setting has been defined to have access to the weighing kit.

Defining the Interface Parameters

MT-SICS command: M87

MT-SICS command: M90

The RS232 channel can be defined with the M87 command. For communication with a PC or PLC use the host channel. With the M90 command the connection parameters can be chosen.

4.3 Setting the Readability

MT-SICS command: M23

The readability is the smallest weight difference that the weigh module can display and transmit via the interface. The WKR204C-S weighing kit, for example, can record differences to 0.1 mg, so the readability d (digit) is 0.1 mg.

Appropriate environmental conditions must be achieved and maintained to measure precisely to 0.1 mg in practice. Also, strong filter damping is usually required, which in turn reduces the weighing rate.

The display increments for the weight query can be changed with the command "**M23**". The existing configuration is then retained but the display increments are rounded accordingly.

4.4 Defining Stability Criteria

MT-SICS command: USTB

If a weighing result meets the stability criterion, the measured value is regarded as stable. The stability criterion is defined by two key figures: The maximum permissible difference (1st key figure) between the largest and smallest weight set measured during a particular observation period (2nd key figure).

Separate stability criteria can be defined for:

- weighing (e.g.: Command: "S")
- the taring function (e.g.: command "T")
- reset (e.g.: command "Z")

If the difference remains below the defined value throughout the observation period, the last measured value is regarded as stable and is transmitted via the interface if required. The difference/tolerance is specified in readability increments (digits) and the observation period in seconds.

Note

The permissible tolerance determines the inaccuracy with which a weighing result is regarded as stable; the observation period in turn defines the minimum possible stabilization time after a change in weight. The greater the tolerance and the shorter the observation period selected, the quicker, but more imprecisely, a stable value will be determined. Whether the stability criterion can be met depends on the filter damping setting and the current environmental conditions, **see** Setting Filter Damping (page 15).

If no parameter are set the default value returns

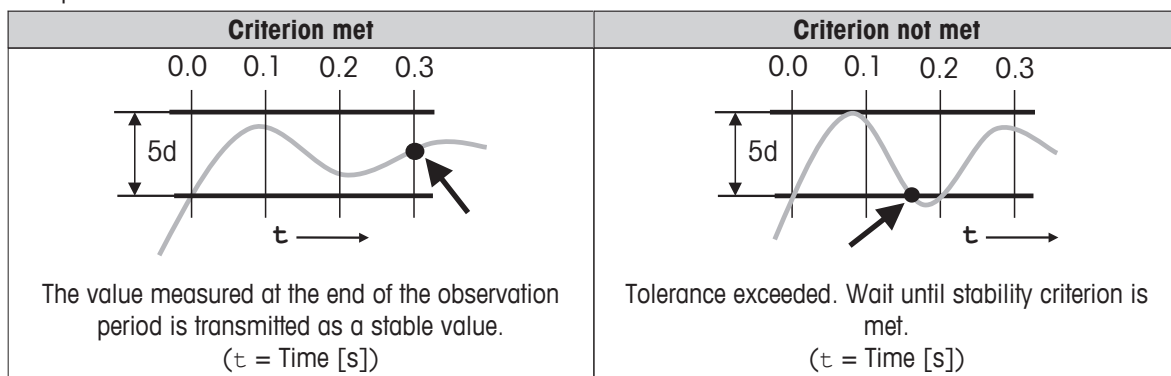

4.5 Selecting the Filter Properties Using the Weighing Type

MT-SICS command: M01

WKR / WKL weighing kits have an adaptive filter in which filter damping is automatically adapted to a change in weight. Linear filters with fixed, configurable damping are also available.

Adaptive Filter – Check Weighing

MT-SICS command: M01_0

The purpose of check weighing is to determine the current weight of the weighing object with reproducibility as quickly as possible after it is applied and to transmit the measurement value. It therefore involves determining a single weight set.

Adaptive filters, whose damping depends on the change in weight over time, are ideal for this job. When the weighing object is applied, the change is large but the damping is very weak. As the change in weight reduces in the stabilization phase, damping increases which leads to increased repeatability since the external influences have little effect. Adaptive filters, set with the command "M01_0" therefore enable you to determine a weight very quickly yet with reproducibility.

Dispensing to a Specified Target Weight

MT-SICS command: M01_2

In this application, the job of the WKR / WKL weighing kit is to measure the increase in weight with as little delay as possible and to forward it to the dispensing system. This information allows the system to regulate the dispensing flow such that the target weight is achieved as quickly and precisely as possible.

Filters with fixed damping (linear filters) are suitable for this type of weighing application, also called gravimetric dispensing. Since it involves determining the weight increase, the weigh module must respond immediately to even the smallest weight change.

4.6 Setting Filter Damping

MT-SICS command: M02

Filter damping determines how quickly the weigh module responds to a change in weight, as well as how sensitive it is to external interference. The stronger the filter damping you set, the more slowly the module will respond to a small weight change and the less sensitive it will be to environmental influences such as air movements and vibrations. This also increases the measurement precision that can be achieved (repeatability). You can also influence the effective measurement precision and the weighing time by setting the stability criteria, see Defining Stability Criteria.

Setting Filter Damping

MT-SICS command: M02

The following filter damping options are available on the WKR / WKL weighing kit:

Damping	Adaptive filter (M01_0)	Fixed filter (M01_2)
Weakest damping (M02_0)	Check weighing in (very) quiet environment	Dispensing, own signal post-processing, limit frequency 3.07 Hz
Weak damping (M02_1)	Precise check weighing in quiet environment	Dispensing in quiet environment, limit frequency 2.07 Hz
Average damping (M02_2)	Check weighing in normal environment	Dispensing in normal environment, limit frequency 1.49 Hz
Strong damping (M02_3)	Check weighing in busy environment	Precise dispensing in normal environment, limit frequency 0.59 Hz
Strongest damping (M02_4)	Precise check weighing in busy environment	Dispensing in busy environment, limit frequency 0.41 Hz

You must determine the level appropriate to your situation empirically by carrying out tests.

We advise you to start with the strongest damping ("M02_4") and to reduce it gradually based on repeatability measurements. Note the influence of the stability criteria. In principle you will achieve greater repeatability in check weighing with weak damping and adaptive filters than with fixed filters.

4.7 Internal and External Adjustment/Test

MT-SICS command: C0 to C3

MT-SICS command: TST0 to TST3

The built-in adjustment weight (in WKR...C models), which is used to automatically check (test) and adjust the module with no manual intervention, has been compared with a traceable weight in the factory. The resulting adjustment factor is stored in the permanent memory of the weigh module (initial adjustment).

The installation location, use of a supporting device (pre-load), or intensive use of the module over a prolonged period can lead to adjustment with the built-in weight failing to achieve the expected precision. You can check whether this is the case at any time using an external weight whose exact value is known (e.g. using a certified weight).

Note

that the pre-load must not exceed 25% of the nominal maximum capacity); otherwise the internal weight cannot be used because of the excessive total load.

Attention

METTLER TOLEDO recommends that you have the WKR / WKL weighing kit regularly checked or adjusted by a qualified METTLER TOLEDO service engineer.

Also see

- Internal and External Adjustment/Test (page 15)

Performing the Internal and External Test Function

MT-SICS command: TST0 to TST3

MT-SICS command: M20

The test function consists of two steps. In the first step, the built-in or external weight of a known value (target value) is applied. The module then calculates the difference between the measured value and the target value and transmits the discrepancy via the interface. Run the command "TST0_0" if you are using the built-in weight for the test function and "TST0_1" if you want to use an external weight. The weight of the external weight must be entered with the command "M20".

Setting the Adjustment Weight

MT-SICS command: C0 to C3

MT-SICS command: M19

Adjustment compensates the WKR / WKL weighing kit in such a way that the measured weight corresponds exactly to the target value of the adjustment weight. This therefore involves compensation in two measurement points, the zero point and the adjustment point. The external adjustment weight must be entered with the command "M19".

4.8 Update Rate for Continuous Weight Transmission

MT-SICS command: UPD

For weighing applications such as dispensing to a specified target weight, the dispensing system must record the weight change continuously so as to regulate the dispensing process. In this case, you can define the number of weight values to be transmitted per second via the interface in what is known as "send continuous" mode.

Note

Note that you must also adjust the baud range of the interface for a high update rate.

Baudrate	update rate
2400	< 5 values / s
4800	< 10 values / s
9600	< 20 values / s
from 19200	all settings

4.9 Programming Tips and Aids**Weigh Module Identification**

MT-SICS command: I10

There are a series of commands to enable the higher-level system to uniquely identify the weigh module. You can query the serial number, model name of the module and other information using the relevant commands. You can use the command "I10" to give each module a unique name.

List of Implemented Interface Commands

MT-SICS command: IO

Command "IO" lists all the commands currently implemented in the module.

Date and Time

MT-SICS command: DAT

MT-SICS command: TIM

The "DAT" and "TIM" commands can be used to set the internal clock in the weigh module and the same commands can be used to query the current time and date. Note that the data is lost if there is a prolonged interruption in the power supply and the clock must be reset.

Cancelling a Running Command

MT-SICS command: @

Recurring commands such as "SIR" or processes such as "C3" can be cancelled with the command "@".

Weight Unit

MT-SICS command: M21

MT-SICS command: M22

The weight unit can be changed with command "M21". The following units are possible, depending on the weight range: g, kg, mg, µg and the user unit "M22".

4.9.1 Error Messages

The WKR / WKL weighing kit transmits an appropriate error code if an internal error is detected.

METTLER TOLEDO recommends that you forward the error number to METTLER TOLEDO if an error occurs so that the cause can be clarified and problem-free operation can be ensured.

If one of the errors below occurs, no more weight values will be transmitted via the interface. The weight value will be overwritten by the respective error code (e.g. S_S_Error_2b).

Error code	Description
Error 1b	Error in the boot monitor
Error 2b	Error in the load cell
Error 3b	Error in the flash memory
Error 4b	Error in the communications interface
Error 5b	Error in the EEPROM memory

5 Weighing Operation Commands and Functions

The actual weighing operation involves weight measurement and transmission of the results to the system via the interface. Depending on the applications, there are various ways of performing a weighing function and transmitting weight values. This section only describes the most important commands you need to use during weighing operations. More commands can be found in the reference book "Standard Interface Command Set MT-SICS for APW weighing modules" (1 1781 363).

5.1 Transmission of Weight Value

The weight values that are transmitted relate either to the zero point or to the point derived from the tare command, depending on whether the previous function executed was a reset to zero or taring.

Note

Commands that are normally only completed when a stability criterion is met respond with an abort if the stability has not been achieved within the defined time limit (Timeout, command "M67").

Functions for transmitting the weight values

MT-SICS command	Description
S	Transmit stable weight value
SC	Transmit stable weight value or dynamic weight value after timeout
SI	Transmit weight value immediately (stable, not stable)
SIR	Transmit weight value immediately and repeat (stable, not stable)
SIS	Transmit net weight value with unit and weight status
SNR	Transmit next stable weight value and repeat
SR	Transmit weight value and repeat when weight changes

5.2 Taring Functions

In taring, the weight value that relates to the current zero point is regarded as the tare weight and is transferred to the tare memory. At the same time, the current weight value is reset to zero.

Available commands

MT-SICS command	Description
T	Adopt current stable weight value as tare weight
TA	Set / query tare weight
TAC	Delete tare weight
TC	Adopt stable weight value within time limit otherwise a dynamic weight value as the tare weight.
TI	Adopt weight value as tare weight immediately.

Note

The taring functions cannot be executed if the current weight value is negative relative to the current zero point.

5.3 Reset Functions

The reset function defines a new zero point (reference point), the current weight value is reset to zero and the tare memory is cleared. Depending on the configuration, the reset is performed automatically whenever the module is switched on or the stored value is used.

The WKR / WKL weighing kit can be reset with the following commands

MT-SICS command	Description
Z	Adopt current stable weight value as zero point
ZC	Adopt stable weight value within time limit otherwise a dynamic weight value as the zero point
ZI	Adopt the current weight value as the zero point immediately

Note

Make sure that a new zero point or a stored zero point is used, depending on the setting when the device is switched on.

6 Optional Display with Key Pad

6.1 Operation Keys

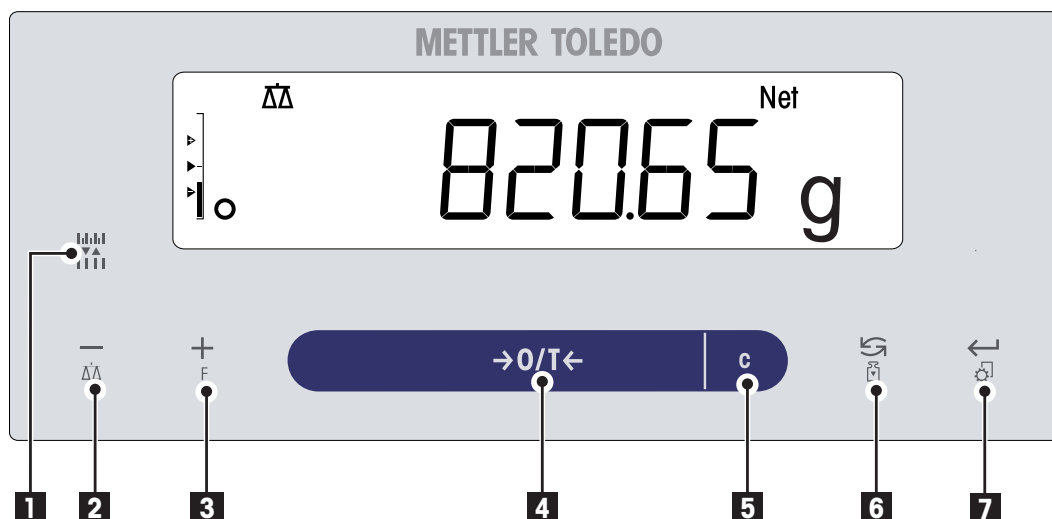

Key Functions

No.	Key	Press briefly (less than 1.5 s)	Press and hold (longer than 1.5 s)
1		<ul style="list-style-type: none"> To change display resolution (1/10d function) while application is running 	no function
2		<ul style="list-style-type: none"> To navigate back (scroll up) within menu topics or menu selections Decrease (numerical) parameters within menu and in applications 	<ul style="list-style-type: none"> To select the weighing application Decrease (numerical) parameters quickly within menu and in applications
3		<ul style="list-style-type: none"> To navigate forward (scroll down) within menu topics or menu selections Increase (numerical) parameters within menu and in applications 	<ul style="list-style-type: none"> To select assigned application and entering the parameter settings of application. Default application assignment: Piece counting Increase (numerical) parameters quickly within menu and in applications
4		<ul style="list-style-type: none"> Zero/Tare 	<ul style="list-style-type: none"> Switch off
5		<ul style="list-style-type: none"> Cancel and to leave menu without saving (one step back in the menu). 	no function
6		<ul style="list-style-type: none"> With entries: scroll down To navigate through menu topics or menu selections To toggle between unit 1, recall value (if selected), unit 2 (if different from unit 1) and the application unit (if any) 	<ul style="list-style-type: none"> Execute predefined adjusting (calibration) procedure

No.	Key	Press briefly (less than 1.5 s)	Press and hold (longer than 1.5 s)
7		<ul style="list-style-type: none"> To enter or leave menu selection (from / to menu topic) To enter application parameter or switch to next parameter To confirm parameter 	<ul style="list-style-type: none"> Enter or leave menu (Parameter settings) Save parameters

6.2 Display Panel

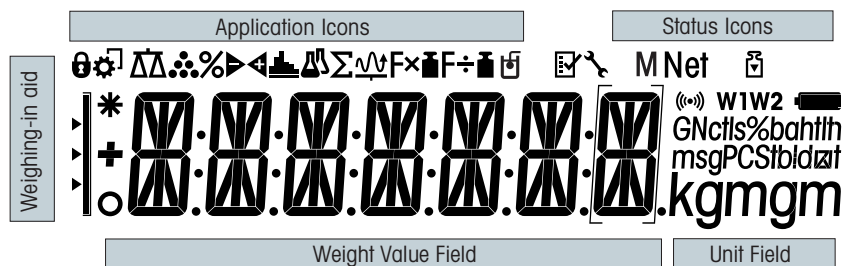

Unit Field						
GNctls%bahth msgPCStbldzt kgmgm	g	gram	ozt	troy ounce	tls	Singapore taels
	kg	kilogram	GN	grain	tlt	Taiwan taels
	mg	milligram	dwt	pennyweight	tola	tola
	ct	carat	mom	momme	baht	baht
	lb	pound	msg	mesghal		
	oz	ounce	tlh	Hong Kong taels		

6.3 Menu Settings



The Menu allows you to match your weighing kit to your specific weighing needs. In the menu you can change the settings of your weighing kit and activate functions. The main menu has 4 different menus and these contains 15 different **topics**, each of which allows you various **selection** possibilities. For Menu "**PROTECT**" see chapter "Description of menu topics" section "Main menu".

Menu "BASIC"

Topic	Description
DATE	Setting the current date.
TIME	Setting the current time.
UNIT 1	Specification of the 1 st weight unit in which the weighing kit should show the result.
UNIT 2	Specification of the 2 nd weight unit in which the weighing kit should show the result.
RESET	Call up of the factory settings.

Menu "ADVANCE."

Topic	Description
ENVIRON.	Matching the weighing kit to the ambient conditions.
CAL	Settings for the type of adjustment (calibration).
DATE.FRM	Setting the date format.
TIME.FRM	Preselection of the time format.
A.ZERO	Switching the automatic zero correction (Autozero) on or off.
ZERO.RNG	Setting the zero limit of the zero/tare key.

Menu "INT.FACE"



Topic	Description
RS232	Matching the serial interface RS232C to a peripheral unit.
BAUD	Setting the transfer speed of the serial interface RS232C.
BIT.PAR.	Setting the character format (Bit/Parity) of the serial interface RS232C.
STOPBIT	Setting the character format (stop bit) of the serial interface RS232C.
HD.SHK	Setting the transfer protocol (Handshake) of the serial interface RS232C.
RS E.O.L.	Setting the end of line format of the serial interface RS232C.
RS.CHAR	Setting the char set of the serial interface RS232C.

6.3.1 Menu Operation

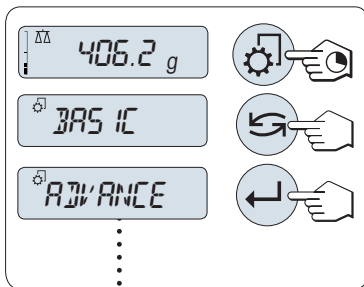
In this Section you will learn how to work with the menu.



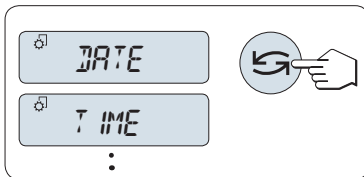

Select Menu

- 1 Press and hold «» to activate main menu. The first menu "BASIC" is displayed (except menu protection is active).
- 2 Press «» repeatedly to change menu (Scrolling down/up «+» / «-» keys).
- 3 Press «» to confirm the selection.



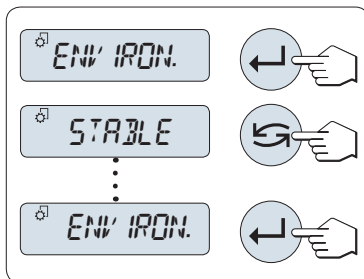

Select Menu Topic

- Press «». The next menu topic appears in the display. Each time the «» or the «+» key is pressed, the weighing kit switches to the next menu topic; the «-» key to the previous menu topic.



Change Settings in a Selected Menu Topic

- 1 Press «». The display shows the current setting in the selected menu topic. Each time «» or «+» is pressed, the weighing kit switches to the next selection; press «-» to the previous selection. After the last selection, the first is shown again.
- 2 Press «» to confirm the setting. For store the setting see section **Saving Settings and Closing the Menu.**

Change Settings in a Submenu Selection

The same procedure as for menu topics.

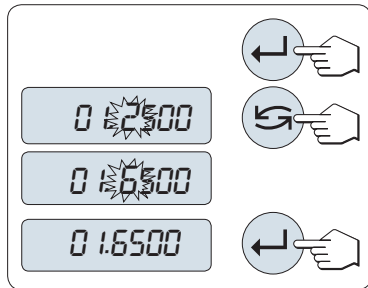

Input Principle of Numerical Values

- 1 Press «←» for input of numerical values.
- 2 Press «→» to select a digit or a value (depending on the application). The selected digit or the selected value is blinking.
- 3 For changing digits or values, press «+» to scroll up or «-» to scroll down.
- 4 Press «←» to confirm the input.

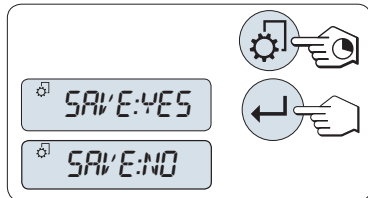

Saving Settings and Closing the Menu

- 1 Press and hold «⚙» to leave menu topic.
- 2 Press «←» to execute "SAVE:YES". Changes are saved.
- 3 Press «←» to execute "SAVE:NO". Changes are not saved. To toggle between "SAVE:YES" and "SAVE:NO" press «↺».



Cancel

- For leaving menu topic or menu selection without saving press «C» (one step back in the menu).

Note: If no entry is made within 30 seconds, the weighing kit reverts to last active application mode. Changes are not saved. If changes are made, the weighing kit asks "SAVE:NO".

6.3.2 Description of Menu Topics

In this Section you will find information regarding the individual menu topics and the available selections.

6.3.2.1 Main Menu

Selecting the menu.

"BASIC"	The small "BASIC" menu for simple weighing is displayed.
"ADVANCE."	The extended "ADVANCE." menu for further weighing settings is displayed.
"INT.FACE"	The menu "INT.FACE" for all interface parameter settings for peripheral devices e.g. printer is displayed.
"PROTECT"	Menu protection. Protection of weighing kit configurations against unmeant manipulation.
"OFF"	Menu protection is off. (Factory setting)
"ON"	Menu protection is on. The menu BASIC , ADVANCE. and INT.FACE are not displayed. This is indicated with "Ⓒ" in the display.

Note:

- The menu selection "BASIC", "ADVANCE." or "INT.FACE" can not be saved.
- To activate "PROTECT" "ON" or "OFF", this selection must be saved.

6.3.2.2 Basic Menu

"DATE" – Date

Setting the current date according to date format.

Note: A reset of the weighing kit will not change this setting.

"TIME" – Time

Setting the current time according to time format

" +1H "	Set the current time forwards by 1 hour (to adjust summer or winter time). (Factory setting)
" -1H "	Set the current time backwards by 1 hour (to adjust summer or winter time).
" SET.TIME "	Enter the current time.

Note: A reset of the balance will not change this setting.

"UNIT 1" – Weight Unit 1

Depending on requirements, the weighing kit can operate with the following units:

Units:

g ¹⁾	Gram	dwt	Pennyweight
kg	Kilogram	mom	Momme
mg	Milligram	msg	Mesghal
ct	Carat	tlh	Tael Hong Kong
lb	Pound	tls ⁴⁾	Tael Singapore
oz	Ounce (avdp)	tlt	Tael Taiwan
ozt	Ounce (troy)	tola	Tola
GN	Grain	baht	Baht

¹⁾ factory setting

"UNIT 2" – Weight Unit 2

If it is required to show the weighing results in weighing mode in an additional unit, the desired second weight unit can be selected in this menu topic (depending on the model). Units see "UNIT 1".

Note: Only those weight units allowed by the appropriate national legislation are selectable.



6.3.2.3 Advanced Menu

"ENVIRON." – Environment Settings

This setting can be used to match your weighing kit to the ambient conditions.

" STD. "	Setting for an average working environment subject to moderate variations in the ambient conditions. (Factory setting)
" UNSTAB. "	Setting for a working environment where the conditions are continuously changing.
" STABLE "	Setting for a working environment which is practically free from drafts and vibrations.

"CAL" – Adjustment (calibration)

In this menu topic you can preselect the function of the «» key. Your weighing kit can be adjusted with internal or external weights by pressing the «» key. If you have attached a printer to your weighing kit, the data of the adjustment (calibration) are printed out.

" ADJ.OFF "	The adjustment is switched off . The «  » key has no function.
--------------------	--

"ADJ.INT"

Internal adjustment: adjustment is performed at a keystroke with the built-in weight (depending on the model, see technical data).

"ADJ.EXT"

External adjustment: adjustment is performed at a keystroke with a selectable external weight.

"200.00 g"

Defining the external adjustment weight: define the weight of the external adjustment weight (in grams).

Factory setting: depends on the model.

"DATE.FRM" – Date Format

This menu topic allows you to preselect the date format.

The following date formats are available:

	Display examples	Printing examples
"DD.MM.Y"	01.02.09	01.02.2009
"MM/DD/Y"	02/01/09	02/01/2009
"Y-MM-DD"	09-02-01	2009-02-01
"D.MMM Y"	1.FEB.09	1.FEB 2009
"MMM D Y"	FEB.1.09	FEB 1 2009

Factory setting: "DD.MM.Y"

"TIME.FRM" – Time Format

This menu topic allows you to preselect the time format.

The following date formats are available:

	Display examples
"24:MM"	15:04
"12:MM"	3:04 PM
"24.MM"	15.04
"12.MM"	3.04 PM

Factory setting: "24:MM"

"B.LIGHT" – Backlight

Under this menu topic, the display backlight can be switched off automatically. If the automatic switch-off is activated, the backlight will turn off automatically after the selected period of inactivity has elapsed. The backlight is reactivated when a key is pressed or the weight is changed.

"B.L. ON"	Backlight is always on . (Factory setting)
"B.L. OFF"	Backlight is always off .
"B.L. 30"	Automatic switch-off after 30 seconds inactivity.
"B.L. 1"	Automatic switch-off after 1 minute inactivity.
"B.L. 2"	Automatic switch-off after 2 minutes inactivity.
"B.L. 5"	Automatic switch-off after 5 minutes inactivity.

"A.ZERO" – Automatic Zero Setting

This menu topic allows you to switch the automatic zero setting on or off.

"ON"	"A.ZERO" switched on (factory setting). The automatic zero setting continuously corrects possible variations in the zero point that might be caused through small amounts of contamination on the weighing pan.
"OFF"	"A.ZERO" switched off . The zero point is not automatically corrected. This setting is advantageous for special applications (e.g. evaporation measurements).

"ZERO.RNG" – Zero Range

This menu topic allows you to set a zero limit for the «→0/T←» key. Up to and including this limit the «→0/T←» key will execute a zero. Above this limit the «→0/T←» key will execute a tare.











"21g" To set the upper limit of the zeroing range as weight in the definition unit of the weighing kit.
(**Factory setting:** 0.5% of weighing range)

Note: A reset of the weighing kit will not change this setting.

6.3.2.4 Interface Menu

"RS232" – RS232C Interface ¹⁾

At this menu topic you can select the peripheral device connected to the RS232C interface and specify how the data is transmitted.

"PRINTER"	Connection to a printer . (Factory setting) Note: <ul style="list-style-type: none">• Only one printer possible.• See recommended printer settings found in section "Appendix", as well as the printer-specific user's manual.
"PRT.STAB"	If the «  » key is pressed, the next stable weight value will be printed. (Factory setting)
"PRT.AUTO"	Every stable weight value will be printed, without pressing the «  » key.
"PRT.ALL"	If the «  » key is pressed, the weight value will be printed regardless of stability.
"PC-DIR."	Connection to a PC : the weighing kit can send data (as a Keyboard) to the PC used for PC applications e.g. Excel. Note: The weighing kit sends the weight value without the unit to the PC.
"PRT.STAB"	If the «  » key is pressed, the next stable weight value will be sent followed by an enter. (Factory setting)
"PRT.AUTO"	Every stable weight value will be sent followed by an enter, without pressing the «  » key.
"PRT.ALL"	If the «  » key is pressed, the weight value will be sent followed by an enter regardless of stability.
"HOST"	Connection to a PC , Barcode Reader etc.: the weighing kit can send data to the PC and receive commands or data from the PC. Note: The weighing kit sends the complete MT-SICS answer to the PC (see chapter "MT-SICS Interface Commands and Functions").
"SND.OFF"	Send mode switched off. (Factory setting)
"SND.STB"	If the «  » key is pressed, the next stable weight value will be sent.
"SND.CONT"	All weight value updates will be sent regardless of stability, without pressing the «  » key.
"SND.AUTO"	Every stable weight value will be sent, without pressing the «  » key.
"SND.ALL"	If the «  » key is pressed, the weight value will be sent regardless of stability.

"2.DISP"

Connection of an **optional auxiliary display** unit.

Note: The transmission parameters cannot be selected. Settings are automatically set.



Attention: If you select 2nd Display "**2.DISP**", first make sure that no other device is connected at COM1 as an auxiliary display. Other devices could be damaged because of the voltage on connector Pin 9. Necessary for powering the display (see Chapter "Interface Specification").

"BAUD" – Baud rate RS232C ¹⁾

This menu topic allows you to match the data transmission to different serial RS232C receivers. The baud rate (data transfer rate) determines the speed of transmission via the serial interface. For problem-free data transmission the sending and receiving devices must be set at the same value.

The following settings are available:

600 bd, 1200 bd, 2400 bd, 4800 bd, 9600 bd, 19200 and 38400 bd. (default: **9600 bd**)

Note:

- Not visible for 2nd display.
- Each device has separate settings.

"BIT.PAR." – Bit/Parity RS232C ¹⁾

At this menu topic you can set the character format for the attached RS232C serial peripheral device.

"8/NO"	8 data bits/no parity (Factory setting)
"7/NO"	7 data bits/no parity
"7/MARK"	7 data bits/mark parity
"7/SPACE"	7 data bits/space parity
"7/EVEN"	7 data bits/even parity
"7/ODD"	7 data bits/odd parity

Note:

- Not visible for 2nd display.
- Each device has separate settings.

"STOPBIT" – Stop Bits RS232C ¹⁾

At this menu topic you can set the stop bits of the transmitted data to different RS232C serial receivers.

"1 BIT"	1 Stop bit (Factory setting)
"2 BITS"	2 Stop bits

Note:

- Not visible for 2nd display.
- Each device has separate settings.

"HD.SHK" – Handshake RS232C ¹⁾

This menu topic allows you to match the data transmission to different RS232C serial receivers.

"XON.XOFF"	Software handshake (XON/XOFF) (Factory setting)
"RTS.CTS"	Hardware handshake (RTS/CTS)
"OFF"	No handshake

Note:

- Not visible for 2nd display.
- Each device has separate settings.

"RS E.O.L." – End of Line RS232C ¹⁾

At this menu topic you can set the "End of Line" character of the transmitted data to different RS232C serial receivers.

"CR LF"	<CR><LF> Carriage Return followed by Line feed (ASCII-Codes 013+010) (Factory setting)
"CR"	<CR> Carriage Return (ASCII-Code 013)
"LF"	<LF> Line feed (ASCII-Code 010)

Note:

- Not visible for 2nd display.
- Each device has separate settings.

"RS.CHAR" – Char Set RS232C ¹⁾

At this menu topic you can set the "Character Set" of the transmitted data to different RS232C serial receivers.

"IBM.DOS"	Char Set IBM/DOS (Factory setting)
"ANSI.WIN"	Char Set ANSI/WINDOWS

Note:



- Not visible for 2nd display.
- Each device has separate settings.

1) Note for 2nd RS232C Interface (COM2)

- If a second interface is installed, the menu topic is displayed for each interface, e.g
"BAUD.1" for standard interface (COM1)
"BAUD.2" for 2nd interface (COM2)
 - Only one printer can be set if two RS232 interfaces are existing.
-

6.4 Error Messages

Error messages in the display draw your attention to incorrect operation or that the weighing kit could not execute a procedure properly.

Error Message	Cause	Rectification
NO STABILITY	No stability.	Ensure more stable ambient conditions. If not possible, check settings for environment.
WRONG ADJUSTMENT WEIGHT	Wrong adjustment weight on pan or none at all.	Place required adjustment weight in center of pan.
REFERENCE TOO SMALL	Reference for piece counting too small.	Increase reference weight.
EEPROM ERROR - PLEASE CONTACT CUSTOMER SERVICE	EEPROM (memory) error.	Please contact METTLER TOLEDO customer service.
WRONG CELL DATA - PLEASE CONTACT CUSTOMER SERVICE	Wrong cell data.	Please contact METTLER TOLEDO customer service.
NO STANDARD ADJUSTMENT - PLEASE CONTACT CUSTOMER SERVICE	No standard calibration.	Please contact METTLER TOLEDO customer service.
PROGRAM MEMORY DEFECT - PLEASE CONTACT CUSTOMER SERVICE	Program memory defect.	Please contact METTLER TOLEDO customer service.
TEMP SENSOR DEFECT - PLEASE CONTACT CUSTOMER SERVICE	Temperature sensor defect.	Please contact METTLER TOLEDO customer service.
WRONG LOAD CELL BRAND - PLEASE CONTACT CUSTOMER SERVICE	Wrong load cell brand.	Please contact METTLER TOLEDO customer service.
WRONG TYPE DATA SET - PLEASE CONTACT CUSTOMER SERVICE	Wrong type data set.	Please contact METTLER TOLEDO customer service.
BATTERY BACKUP LOST - CHECK DATE TIME SETTINGS	Backup battery is empty. This battery ensures that the date and time are not lost when the weighing kit is disconnected from power.	Connect the weighing kit to the power supply for charging the battery (e.g. during the night) or contact METTLER TOLEDO customer service.
	Overload - The weight on the pan exceeds the weighing capacity of the weighing kit.	Reduce the weight on the weighing pan.
	Underload	Check that the weighing pan is positioned correctly.
ABOVE INITIAL ZERO RANGE	Wrong weighing pan or pan is not empty.	Mount correct weighing pan or unload weighing pan.
BELOW INITIAL ZERO RANGE	Wrong weighing pan or pan is missing.	Mount correct weighing pan.
MEM.FULL	Memory full.	Clear the memory and start a new evaluation.
FACTOR OUT OF RANGE	Factor is outside the allow range.	Select a new factor.
STEP OUT OF RANGE	Step is outside the allow range.	Select a new step.
OUT OF RANGE	Sample weight is outside the allow range.	Unload the pan and load a new sample weight.

7 Maintenance

7.1 Cleaning

Your load cell as well as the weighing pan or the display overlay is made from high quality, resistant materials and can therefore be cleaned with a commercially available, mild cleaning agent e.g. isopropanol.

Attention

- Use a lint-free cloth for cleaning.
- Ensure that no liquids enters the interior of the load cell.
- On no account use cleaning agents, which contain solvents or abrasive ingredients, as this can result in damage to the display overlay.
- Never open the housing of the load cell – they contain no components which can be cleaned, repaired or replaced by the user.

7.2 Disposal



In conformance with the European Directive 2002/96/EC on Waste Electrical and Electronic Equipment (WEEE) this device may not be disposed of in domestic waste. This also applies to countries outside the EU, per their specific requirements.

Please dispose of this product in accordance with local regulations at the collecting point specified for electrical and electronic equipment. If you have any questions, please contact the responsible authority or the distributor from which you purchased this device. Should this device be passed on to other parties (for private or professional use), the content of this regulation must also be related.

Thank you for your contribution to environmental protection.

8 Technical Data

8.1 General Data

Power Supply

- AC operation: AC/DC Adapter
Primary: 100V–240V, 50/60Hz, 0.3 A
Secondary: 12V DC, 0.84A (with electronic overload protection)
Power supply to the weighing kit: 8–20V DC, 10W



Use only with a tested AC Adapter with SELV output current.
Ensure correct polarity \ominus \bullet \oplus

Protection and Standards

- Overvoltage categorie: Class III
- Degree of pollution: 2
- Degree of protection: IP20
- Standards for safety and EMC: Weighing Kits complies with 2006/95/EC LVD only. The weighing kit must not be put into service until the equipment/system into which it is to be incorporated has been declared in conformity with the provisions of the directive.
- Range of application: For use only in dry interior rooms

Environmental conditions

- Height above mean sea level: up to 4000 m
- Ambient temperature range: 10 to 30 °C
- Relative air humidity: 10% to 80 % at 31 °C, linearly decreasing to 50 % at 40 °C, non-condensing

Materials

- Housing: Housing: Plastic (PS)
Baseplate: Die-cast aluminum
- Weighing pan: Stainless steel X2CrNiMo 17-12-2 (1.4404)

8.2 Model-specific Data

Technical Data

	WKR204C-S	WKR603C-S	WKL1502-S	
Limit values				
Maximum capacity	220 g	620 g	1520 g	
Readability	0.1 mg	0.001 g	0.01 g	
Repeatability (at nominal load)	0.1 mg	0.001 g	0.01 g	
Linearity deviation	0.2 mg	0.002 g	0.02 g	
Sensitivity temperature drift	0.00015 %/°C	0.0003 %/°C	0.0003 %/°C	
Typical values				
Minimum sample weight (acc. to USP)	0.3 g	2.1 g	21 g	
Minimum sample weight (U=1 %, k=2)	0.02 g	0.02 g	0.14 g	
Settling time	2 s	1.5 s	1.5 s	
Adjustment	Int. Cal	Int. Cal	Ext. Cal	
Weighing pan dimensions	Ø 90 mm	Ø 120 mm	Ø 120 mm	
Weights for routine testing				
	Weights	200 g F2, 10 g F1	500 g F2, 20 g F1	1000 g F2, 50 g F1
OIML CarePac		#11123001	#11123007	#11123008

9 Mechanical Dimensions

9.1 Load Cell

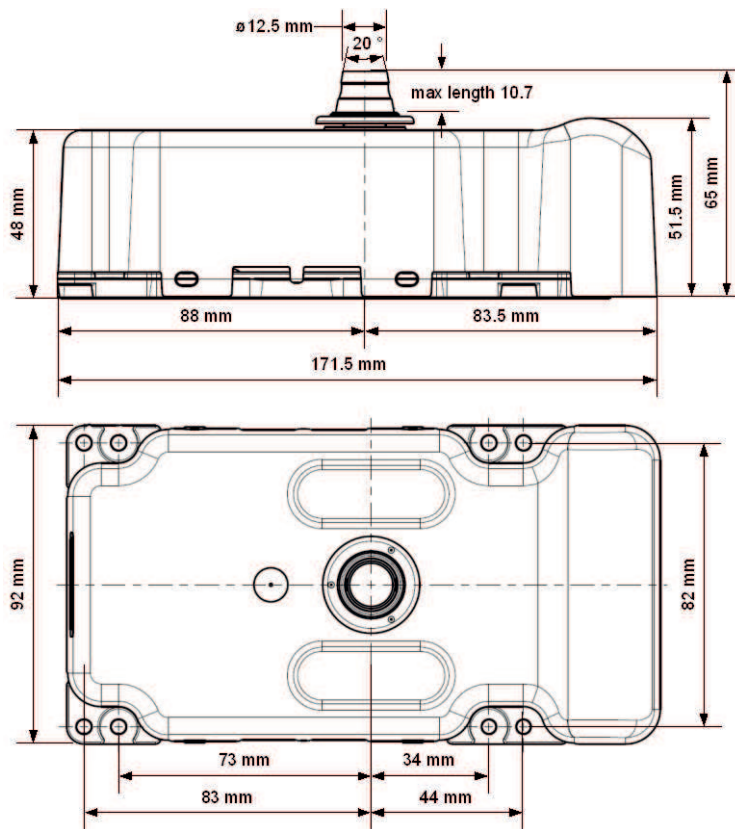

9.2 Mainboard

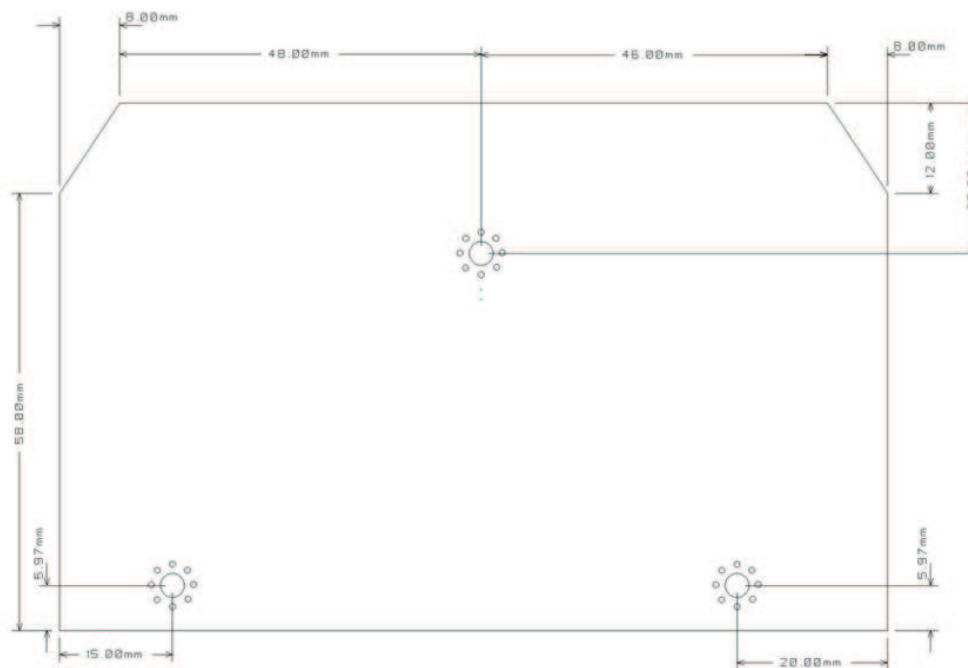

9.3 Connector Board

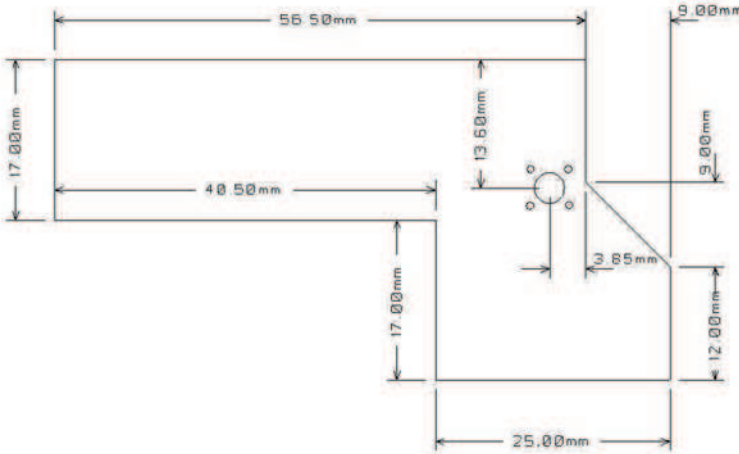





9.4 Optional Display

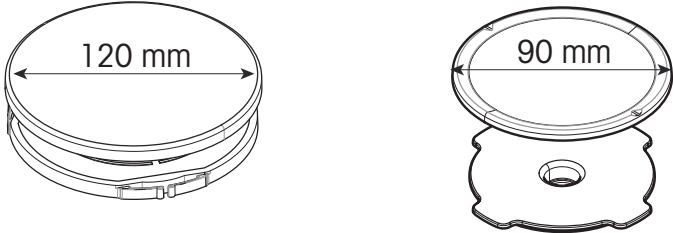

9.5 Optional Weighing Pan

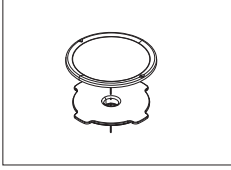
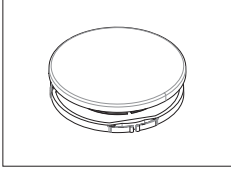

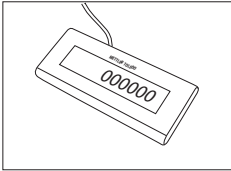
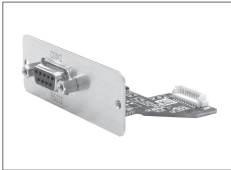
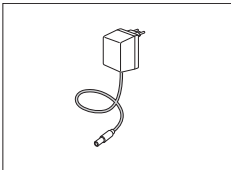
10 Accessories

	Description	Part No.
Weighing pans		
	<p>Weighing pan with support for 0.1 mg weighing Kits. No built-in anti rotation.</p> <ul style="list-style-type: none"> • Weighing pan • Pan support 	<p>12122010</p> <p>12122042</p>
	<p>Weighing pan with support Ø 120 mm for 1 mg weighing Kits. No built-in anti rotation.</p> <ul style="list-style-type: none"> • Weighing pan • Pan support 	<p>12122037</p> <p>12122045</p>
Displays		
	Display with Keypad (built-in type)	30208123
	RS232 auxiliary display AD-RS-M7	12122381
Interfaces		
	Second RS232 Interface	30208196
Power supplies		
	AC/DC universal adapter (EU, USA, AU, UK) 100–240 VAC, 50/60 Hz, 0.3 A, 12 VDC 0.84 A	11120270
Adjustment weights		
	OIML / ASTM Weights (with calibration certificate) see www.mt.com/weights	

11 Appendix

11.1 Conversion Table for Weight Units

Kilogram	1 kg	=	1000.0	g	1 g	=	0.001	kg
Milligram	1 mg	=	0.001	g	1 g	=	1000.0	mg
Microgram	1 µg	=	0.000001	g	1 g	=	1000000.0	µg
Carat	1 ct	=	0.2	g	1 g	=	5.0	ct
Pound	1 lb	=	453.59237	g	1 g	≈	0.00220462262184878	lb
Ounce (avdp)	1 oz	=	28.349523125	g	1 g	≈	0.0352739619495804	oz
Ounce (troy)	1 ozt	=	31.1034768	g	1 g	≈	0.0321507465686280	ozt
Grain	1 GN	=	0.06479891	g	1 g	≈	15.4323583529414	GN
Pennyweight	1 dwt	=	1.55517384	g	1 g	≈	0.643014931372560	dwt
Momme	1 mom	=	3.75	g	1 g	≈	0.266666666666667	mom
Mesghal	1 msg	≈	4.6083	g	1 g	≈	0.217	msg
Tael Hong Kong	1 tlh	=	37.429	g	1 g	≈	0.0267172513291833	tlh
Tael Singapore (Malaysia)	1 tfs	≈	37.7993641666667	g	1 g	≈	0.0264554714621853	tfs
Tael Taiwan	1 tlt	=	37.5	g	1 g	≈	0.0266666666666667	tlt
Tola	1 tola	=	11.6638038	g	1 g	≈	0.0857353241830079	tola
Baht	1 baht	=	15.16	g	1 g	≈	0.0659630606860158	baht

12 Index

A

Accessories	34
Adjustment	15, 24
Advanced menu	21
Ambient conditions	9
Automatic zero setting	25
Autozero	25

B

Backlight	25
Basic menu	21
Baudrate	27
Bit/Parity	27

C

Calibration	24
Cancel	23
Change settings	22, 22
Char Set	28
Closing the menu	23
Conventions and symbols	5
Conversion table for weight units	35

D

Date	17, 24
Date format	25
Display	27
Disposal	30

E

End of Line	28
Environment	24
Error messages	29
Error Messages	17

F

Filter	
Adaptive filter	14
Filter damping	14, 15

G

General safety information	6
----------------------------	---

H

Handshake	27
Host	26

I

Initial adjustment	15
Input principle	22
Interface	
RS232	13
Interface menu	22, 26
Interface RS232C	26

K

Key functions	20
---------------	----

L

Leveling the balance	9
Location	9

M

Main Menu	23
Menu	21, 23
Menu Advanced	21
Menu Basic	21
Menu Interface	22, 26
Menu operation	22
Menu protection	23
Menu topic	22, 22
MT-SICS	
Commands	13, 18
Manual	13, 18

N

Numerical values	22
------------------	----

O

Operation keys	20
----------------	----

P

PC-DIR	26
Printer	26
Protect	23

R

Readability	13
RS232C interface	26

S

Safety Information	
General	6
Signal words	6
Warning Symbols	6
Saving settings	23
Select menu	22
Select menu topic	22
Selecting the location	9
Signal words	6
Stability criteria	14
Stop bit	27
Submenu	22
Symbols and conventions	5

T

Technical data general	31
Technical data model-specific	31
Test	15
Time	17, 24
Time format	25
Topic	22, 22

U

Unit	24, 24
Update rate	16

W

Warning Symbols	6
Weighing	
operation	18
Weight unit	17, 24, 24, 35

Z

Zero range	26
Zeroing	25

GWP® – Good Weighing Practice™

The global weighing guideline GWP® reduces risks associated with your weighing processes and helps to

- choose the appropriate balance
- reduce costs by optimizing testing procedures
- comply with the most common regulatory requirements

► www.mt.com/GWP

www.mt.com/apw

For more information

Mettler-Toledo AG
CH-8606 Nänikon, Switzerland
www.mt.com

Subject to technical changes.
© Mettler-Toledo AG 10/2012
30063872A en

